

# XS Wireless 1 | XS Wireless 2

Instruction Manual



## **PRODUCT INFORMATION 4**

### **Products of the XS Wireless line 4**

- EM-XSW 1 stationary receiver 5
- EM-XSW 1 DUAL rack receiver 5
- EM-XSW 2 stationary receiver 6
- SKM 825-XSW handheld transmitter 7
- SKM 835-XSW handheld transmitter 8
- SKM 865-XSW handheld transmitter 9
- SK-XSW bodypack transmitter 10

### **Available sets 11**

- XSW 1-825 | Vocal Set 11
- XSW 1-835 | Vocal Set 12
- XSW 1-825 DUAL | Vocal Set 13
- XSW 1-835 DUAL | Vocal Set 14
- XSW 1-CI1 | Instrument Set 15
- XSW 1-908 | Instrument Set 16
- XSW 1-ME2 | Lavalier Set 17
- XSW 1-ME3 | Headmic Set 18
- XSW 2-835 | Vocal Set 19
- XSW 2-865 | Vocal Set 20
- XSW 2-CI1 | Instrument Set 21
- XSW 2-ME2 | Lavalier Set 22
- XSW 2-ME3 | Headmic Set 23

### **Accessories 24**

- GA 1-XSW 2 rack mount kit 24
- GA 2-XSW 2 antenna front mount kit 24

### **Frequency ranges 25**

## **INSTRUCTION MANUAL 26**

### **Starting up and operating devices of the XS Wireless line 26**

#### **EM-XSW 1 rack receiver 28**

- Connectors and controls 28
  - Front 28
  - Back 29
- Connecting/disconnecting the receiver to/from the power supply system 30
- Outputting audio signals 31
- Switching the receiver on and off 32
- Information on the receiver's display 33
- Setting options on the front of the device 35
  - Navigation buttons 35
  - Setting the frequency automatically (AUTO SCAN) 35
  - Setting the frequency manually 36
  - Adjusting the volume of the audio outputs 38
- Setting options on the rear of the device 39
  - Selecting the signal type (Mic/Line) 39
  - Setting the squelch 39
- Configuring a multi-channel system 40

#### **EM-XSW 1 DUAL rack receiver 41**

- Connectors and controls 41



- Front 41
- Back 42
- Connecting/disconnecting the receiver to/from the power supply system 43
- Outputting audio signals 44
- Switching the receiver on and off 45
- Information on the receiver's display 46
- Setting options on the front of the device 48
  - Navigation buttons 48
  - Setting the frequency automatically (AUTO SCAN) 48
  - Setting the frequency manually 50
  - Adjusting the volume of the audio outputs 52
- Setting options on the rear of the device 53
  - Selecting the signal type (Mic/Line) 53
  - Setting the squelch 53
- Configuring a multi-channel system 54
- EM-XSW 2 rack receiver 55**
  - Connectors and controls 55
    - Front 55
    - Back 56
  - Connecting/disconnecting the receiver to/from the power supply system 57
  - Connecting antennas 58
  - Outputting audio signals 59
  - Installing receivers in a rack 60
    - Mounting a single receiver in a rack 61
    - Mounting two receivers side by side in a rack 62
  - Switching the receiver on and off 63
  - Information on the receiver's display 64
    - Further information 64
  - Setting options on the front of the device 66
    - Navigation buttons 66
    - SCAN menu item 67
    - PRESET menu item 68
    - TUNE menu item 70
    - Adjusting the volume of the audio outputs 71
  - Setting options on the rear of the device 72
    - Selecting the signal type (Mic/Line) 72
    - Setting the squelch 72
  - Configuring a multi-channel system 73
- Handheld transmitters SKM 825-XSW | SKM 835-XSW | SKM 865-XSW 74**
  - Product overview 74
  - Inserting and removing the batteries 75
    - Battery status 76
  - Switching the handheld transmitter on and off 77
  - Establishing a connection to the receiver 77
  - Information on the handheld transmitter's display 78
    - Further information 78
  - Setting the input sensitivity 79
  - Muting the handheld transmitter 80



## **SK-XSW bodypack transmitter 81**

Product overview 81

Inserting and removing the batteries 82

Battery status 83

Connecting a microphone to the bodypack transmitter 84

Connecting an instrument or line source to the bodypack transmitter 84

Switching the bodypack transmitter on and off 86

Establishing a connection to the receiver 86

Information on the bodypack transmitter's display 87

Further information 87

Setting the input sensitivity 88

Muting the bodypack transmitter 89

## **Establishing a radio link | Synchronizing the receiver and transmitter 90**

## **Cleaning and maintenance 92**

## **SPECIFICATIONS 94**

### **System 94**

EM-XSW 1 stationary receiver 96

EM-XSW 1 DUAL rack receiver 98

EM-XSW 2 stationary receiver 100

SKM-XSW handheld transmitter 102

SK-XSW bodypack transmitter 104

### **Microphones 105**

ME 2-2 105

ME 3-II 105

e 908T 106

NT 12-5 CW power supply unit 107

## **CONTACT 109**

Questions about the product / Help with technical issues 109

Feedback on the instruction manual 109



## PRODUCT INFORMATION

### Products of the XS Wireless line

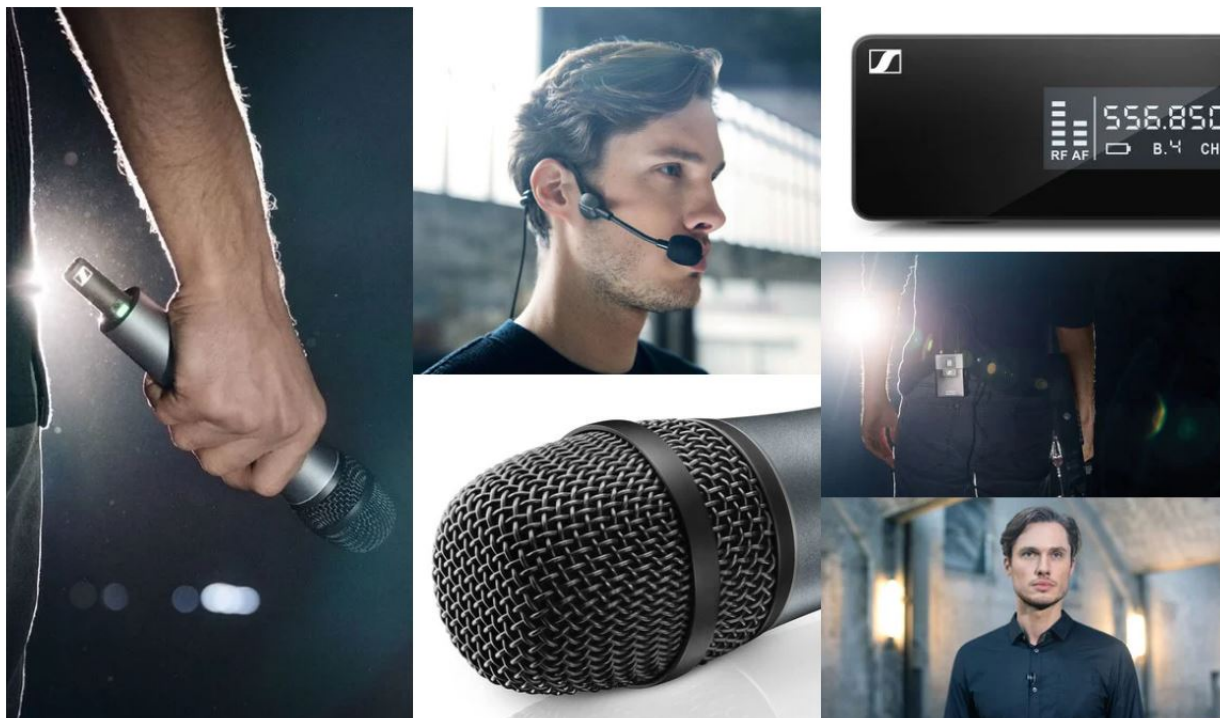

---

For information about the available **accessories**, see „Accessories“.

---

For information about the available **sets**, see „Available sets“.

---

For information about the **frequency ranges**, see „Frequency ranges“.

---

You can find technical **specifications** for the series and the individual products under „SPECIFICATIONS“.

---

You can find information about **starting up** and **operating** the products under „Starting up and operating devices of the XS Wireless line“.



## EM-XSW 1 stationary receiver



**i** You can find more detailed information about the EM-XSW 1 in the following sections:

- ▷ **Startup and operation:** „EM-XSW 1 rack receiver“
- ▷ **Specifications:** „EM-XSW 1 stationary receiver“

## EM-XSW 1 DUAL rack receiver

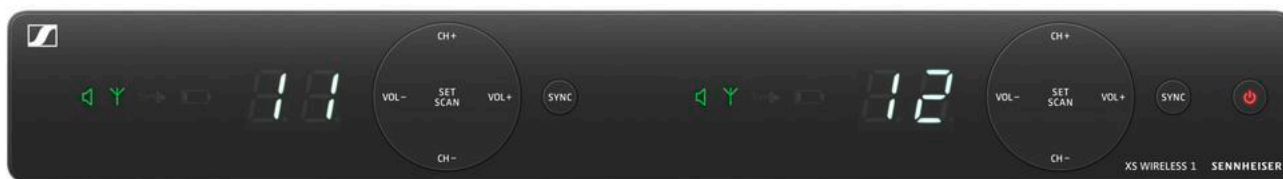

**i** You can find more detailed information about the EM-XSW 1 DUAL in the following sections:

- ▷ **Startup and operation:** „EM-XSW 1 DUAL rack receiver“
- ▷ **Specifications:** „EM-XSW 1 DUAL rack receiver“





## EM-XSW 2 stationary receiver



You can find more detailed information about the EM-XSW 2 in the following sections:

- ▷ **Startup and operation:** „EM-XSW 2 rack receiver“
- ▷ **Specifications:** „EM-XSW 2 stationary receiver“



## SKM 825-XSW handheld transmitter



Handheld transmitter with e825 microphone capsule

---



You can find more detailed information about the SKM-XSW in the following sections:

- ▷ **Startup and operation:** „Handheld transmitters SKM 825-XSW | SKM 835-XSW | SKM 865-XSW“
  - ▷ **Specifications:** „SKM-XSW handheld transmitter“
-





## SKM 835-XSW handheld transmitter



Handheld transmitter with e835 microphone capsule

---



You can find more detailed information about the SKM-XSW in the following sections:

- ▷ **Startup and operation:** „Handheld transmitters SKM 825-XSW | SKM 835-XSW | SKM 865-XSW“
  - ▷ **Specifications:** „SKM-XSW handheld transmitter“
-



## SKM 865-XSW handheld transmitter



Handheld transmitter with e865 microphone capsule

---



You can find more detailed information about the SKM-XSW in the following sections:

- ▷ **Startup and operation:** „Handheld transmitters SKM 825-XSW | SKM 835-XSW | SKM 865-XSW“
  - ▷ **Specifications:** „SKM-XSW handheld transmitter“
-



## SK-XSW bodypack transmitter



You can find more detailed information about the SK-XSW in the following sections:

- ▷ **Startup and operation:** „SK-XSW bodypack transmitter“
- ▷ **Specifications:** „SK-XSW bodypack transmitter“



## Available sets

### XSW 1-825 | Vocal Set



The set consists of the following components:

- „EM-XSW 1 stationary receiver“
- „SKM 825-XSW handheld transmitter“
- MZQ 1 microphone clamp
- Power supply with country adapters
- 2 AA LR6 batteries, 1.5 V



You can find more detailed information about the set in the following sections:

- ▷ **Startup and operation:** „Starting up and operating devices of the XS Wireless line“
- ▷ **Specifications:** „SPECIFICATIONS“



## XSW 1-835 | Vocal Set



The set consists of the following components:

- „EM-XSW 1 stationary receiver“
- „SKM 835-XSW handheld transmitter“
- MZQ 1 microphone clamp
- Power supply with country adapters
- 2 AA LR6 batteries, 1.5 V



You can find more detailed information about the set in the following sections:

- ▷ **Startup and operation:** „Starting up and operating devices of the XS Wireless line“
- ▷ **Specifications:** „SPECIFICATIONS“



## XSW 1-825 DUAL | Vocal Set

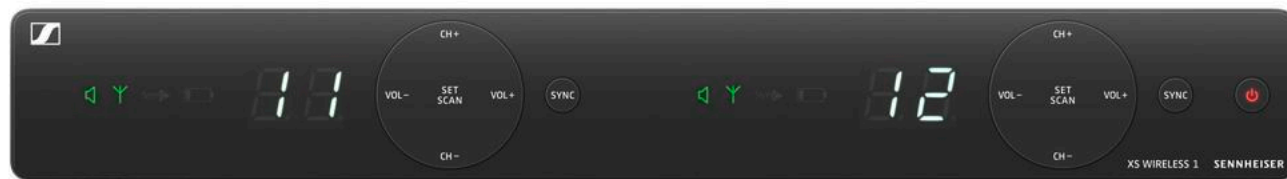

The set consists of the following components:

- „EM-XSW 1 DUAL rack receiver“
- 2x „SKM 825-XSW handheld transmitter“
- 2x MZQ 1 microphone clamp
- Power supply with country adapters
- 4 AA LR6 batteries, 1.5 V



You can find more detailed information about the set in the following sections:

- ▷ **Startup and operation:** „Starting up and operating devices of the XS Wireless line“
- ▷ **Specifications:** „SPECIFICATIONS“





## XSW 1-835 DUAL | Vocal Set

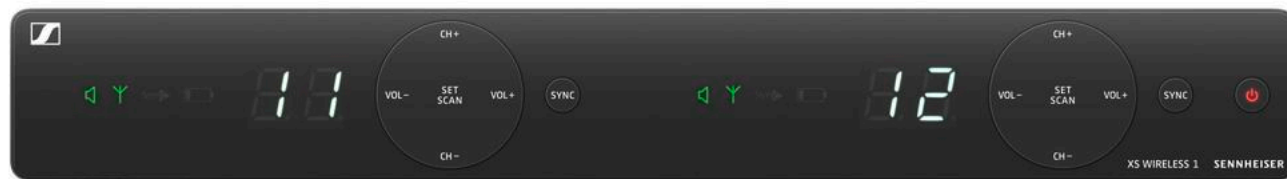

The set consists of the following components:

- „EM-XSW 1 DUAL rack receiver“
- 2x „SKM 835-XSW handheld transmitter“
- 2x MZQ 1 microphone clamp
- Power supply with country adapters
- 4 AA LR6 batteries, 1.5 V



You can find more detailed information about the set in the following sections:

- ▷ **Startup and operation:** „Starting up and operating devices of the XS Wireless line“
- ▷ **Specifications:** „SPECIFICATIONS“



## XSW 1-CI1 | Instrument Set



The set consists of the following components:

- „EM-XSW 1 stationary receiver“
- „SK-XSW bodypack transmitter“
- CI 1 instrument cable
- Power supply with country adapters
- 2 AA LR6 batteries, 1.5 V



You can find more detailed information about the set in the following sections:

- ▷ **Startup and operation:** „Starting up and operating devices of the XS Wireless line“
- ▷ **Specifications:** „SPECIFICATIONS“



## XSW 1-908 | Instrument Set



The set consists of the following components:

- „EM-XSW 1 stationary receiver“
- „SK-XSW bodypack transmitter“
- e 908T instrument microphone
- Power supply with country adapters
- 2 AA LR6 batteries, 1.5 V



You can find more detailed information about the set in the following sections:

- ▷ **Startup and operation:** „Starting up and operating devices of the XS Wireless line“
- ▷ **Specifications:** „SPECIFICATIONS“



## XSW 1-ME2 | Lavalier Set



The set consists of the following components:

- „EM-XSW 1 stationary receiver“
- „SK-XSW bodypack transmitter“
- ME 2 lavalier microphone
- Power supply with country adapters
- 2 AA LR6 batteries, 1.5 V



You can find more detailed information about the set in the following sections:

- ▷ **Startup and operation:** „Starting up and operating devices of the XS Wireless line“
- ▷ **Specifications:** „SPECIFICATIONS“



## XSW 1-ME3 | Headmic Set



The set consists of the following components:

- „EM-XSW 1 stationary receiver“
- „SK-XSW bodypack transmitter“
- ME 3 headset microphone
- Power supply with country adapters
- 2 AA LR6 batteries, 1.5 V



You can find more detailed information about the set in the following sections:

- ▷ **Startup and operation:** „Starting up and operating devices of the XS Wireless line“
- ▷ **Specifications:** „SPECIFICATIONS“



## XSW 2-835 | Vocal Set



The set consists of the following components:

- „EM-XSW 2 stationary receiver“
- „SKM 835-XSW handheld transmitter“
- MZQ 1 microphone clamp
- Rack mount kit
- Power supply with country adapters
- 2 AA LR6 batteries, 1.5 V



You can find more detailed information about the set in the following sections:

- ▷ **Startup and operation:** „Starting up and operating devices of the XS Wireless line“
- ▷ **Specifications:** „SPECIFICATIONS“





## XSW 2-865 | Vocal Set



The set consists of the following components:

- „EM-XSW 2 stationary receiver“
- „SKM 865-XSW handheld transmitter“
- MZQ 1 microphone clamp
- Rack mount kit
- Power supply with country adapters
- 2 AA LR6 batteries, 1.5 V



You can find more detailed information about the set in the following sections:

- ▷ **Startup and operation:** „Starting up and operating devices of the XS Wireless line“
- ▷ **Specifications:** „SPECIFICATIONS“



## XSW 2-CI1 | Instrument Set



The set consists of the following components:

- „EM-XSW 2 stationary receiver“
- „SK-XSW bodypack transmitter“
- CI 1 instrument cable
- Rack mount kit
- Power supply with country adapters
- 2 AA LR6 batteries, 1.5 V



You can find more detailed information about the set in the following sections:

- ▷ **Startup and operation:** „Starting up and operating devices of the XS Wireless line“
- ▷ **Specifications:** „SPECIFICATIONS“



## XSW 2-ME2 | Lavalier Set



The set consists of the following components:

- „EM-XSW 2 stationary receiver“
- „SK-XSW bodypack transmitter“
- ME 2 lavalier microphone
- Rack mount kit
- Power supply with country adapters
- 2 AA LR6 batteries, 1.5 V



You can find more detailed information about the set in the following sections:

- ▷ **Startup and operation:** „Starting up and operating devices of the XS Wireless line“
- ▷ **Specifications:** „SPECIFICATIONS“



## XSW 2-ME3 | Headmic Set



The set consists of the following components:

- „EM-XSW 2 stationary receiver“
- „SK-XSW bodypack transmitter“
- ME 3 headset microphone
- Rack mount kit
- Power supply with country adapters
- 2 AA LR6 batteries, 1.5 V



You can find more detailed information about the set in the following sections:

- ▷ **Startup and operation:** „Starting up and operating devices of the XS Wireless line“
- ▷ **Specifications:** „SPECIFICATIONS“



## Accessories

### GA 1-XSW 2 rack mount kit

19" rack adapter for mounting the EM-XSW 2 in a 19" rack.

Art. no. 507351



### GA 2-XSW 2 antenna front mount kit

Antenna front mount kit for installing antenna connections on the front of the rack when using the EM-XSW 2 together with the GA 1-XSW 2 rack mount kit.

Art. no. 507468





## Frequency ranges

The products are available in the following frequency ranges.



Click a frequency range in the list to open a frequency table with factory presets for this frequency range.

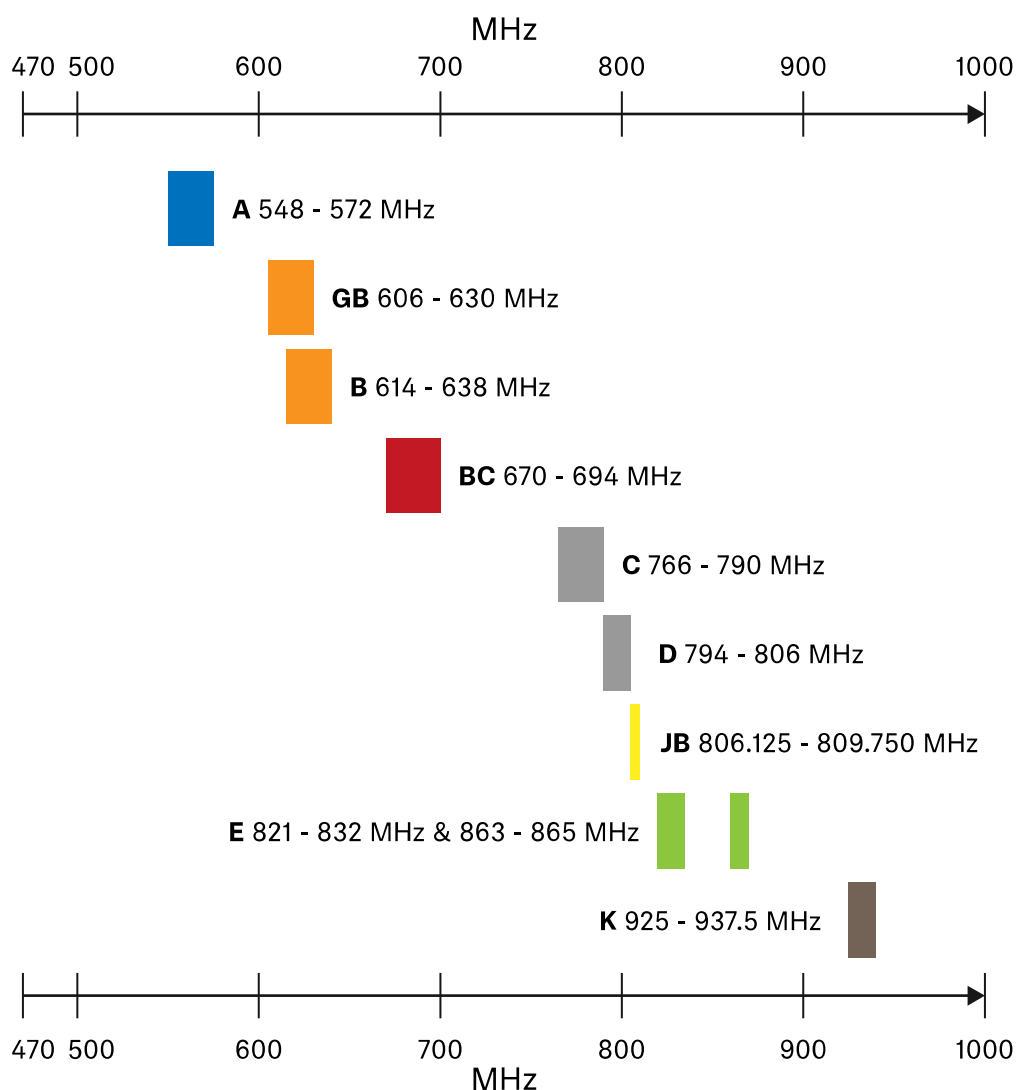

### Conditions and restrictions for using frequencies

There may be special conditions and restrictions for using frequencies in your country.

Before putting the product into operation, find the information for your country at the following address:

[www.sennheiser.com/sifa](http://www.sennheiser.com/sifa)





## INSTRUCTION MANUAL

### Starting up and operating devices of the XS Wireless line

---



„EM-XSW 1 rack receiver“

---



„EM-XSW 1 DUAL rack receiver“

---



„EM-XSW 2 rack receiver“

---

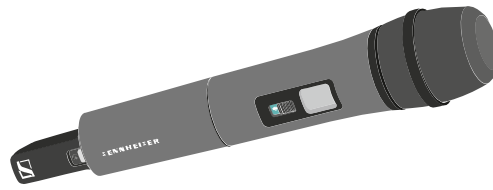

„Handheld transmitters SKM 825-XSW | SKM 835-XSW | SKM 865-XSW“

---



„SK-XSW bodypack transmitter“

---



„Establishing a radio link | Synchronizing the receiver and transmitter“

---

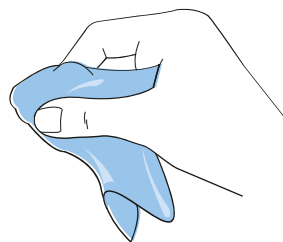

„Cleaning and maintenance“



## EM-XSW 1 rack receiver

### Connectors and controls

#### Front

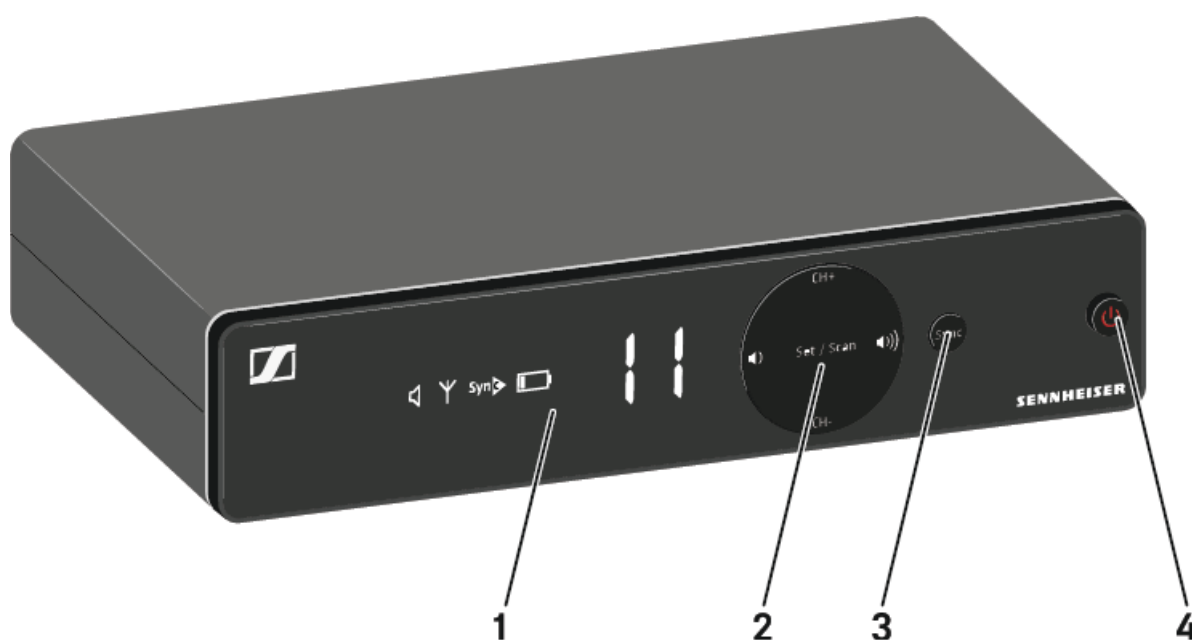

- 1** Display for status information
  - See „Information on the receiver’s display“
- 2** Control buttons for selecting channels and adjusting volume
  - See „Setting options on the front of the device“
- 3** **SYNC** button for synchronizing the transmitter and receiver
  - See „Establishing a radio link | Synchronizing the receiver and transmitter“
- 4** **ON/OFF** button for switching the device on and off
  - See „Switching the receiver on and off“



## Back

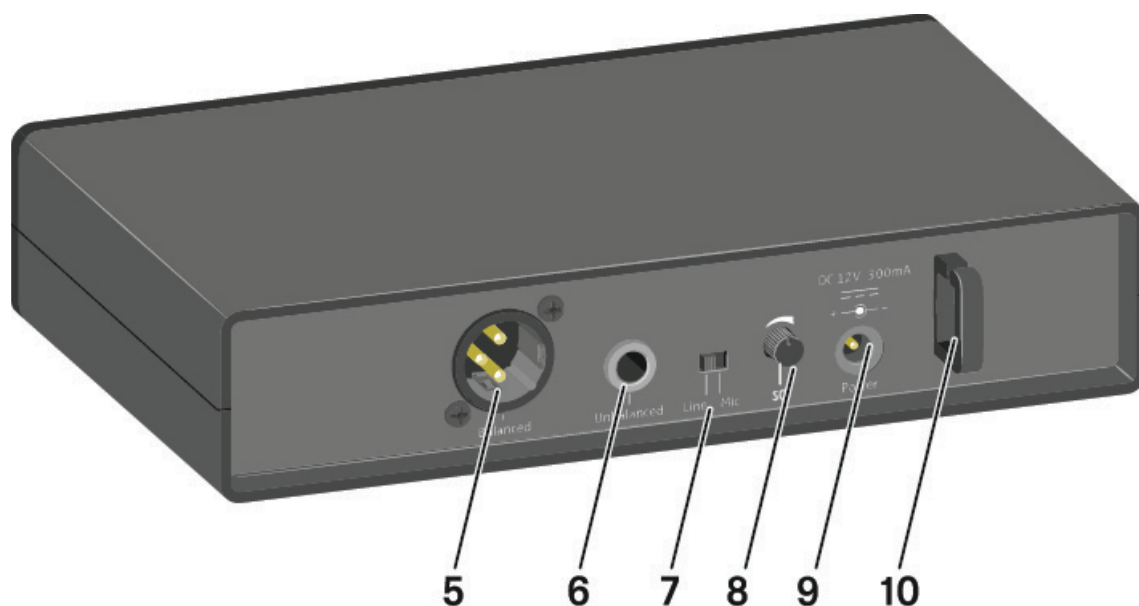

- 5** XLR-3 socket for **Balanced** audio output
  - See „Outputting audio signals“
- 6** 6.3 mm jack socket for **Unbalanced** audio output
  - See „Outputting audio signals“
- 7** **Line/Mic** switch for selecting the signal type
  - See „Setting options on the rear of the device“
  - See „Outputting audio signals“
- 8** SQ control knob for adjusting the squelch value
  - See „Setting options on the rear of the device“
- 9** **Power** connection socket for the power supply unit
  - See „Connecting/disconnecting the receiver to/from the power supply system“
- 10** Strain relief for the connection cable of the power supply unit
  - See „Connecting/disconnecting the receiver to/from the power supply system“



## Connecting/disconnecting the receiver to/from the power supply system

Only use the supplied power supply unit. It is designed for your receiver and ensures safe operation.

To connect the receiver to the power supply system:

- ▷ Pass the cable of the power supply unit through the strain relief.
- ▷ Insert the plug of the power supply unit into the **Power** socket on the receiver.
- ▷ Slide the supplied country adapter onto the power supply unit.
- ▷ Plug the power supply unit into the wall socket.

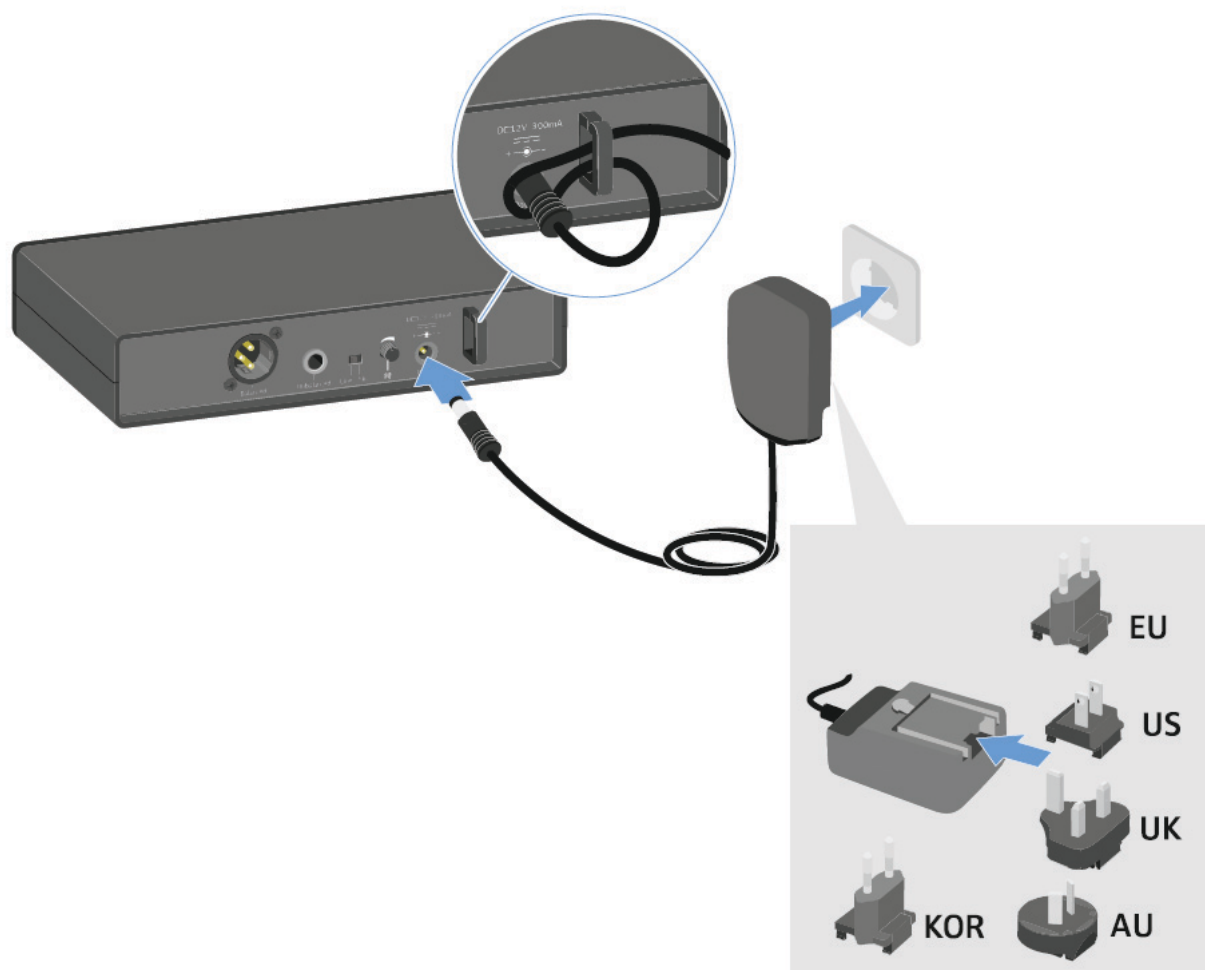

To completely disconnect the receiver from the power supply system:

- ▷ Unplug the power supply unit from the wall socket.
- ▷ Unplug the power supply unit from the **Power** socket on the receiver.



## Outputting audio signals

The EM-XSW 1 has a balanced XLR-3M output socket and an unbalanced 6.3 mm jack output socket.

- ▷ Always use only one of the two output sockets.

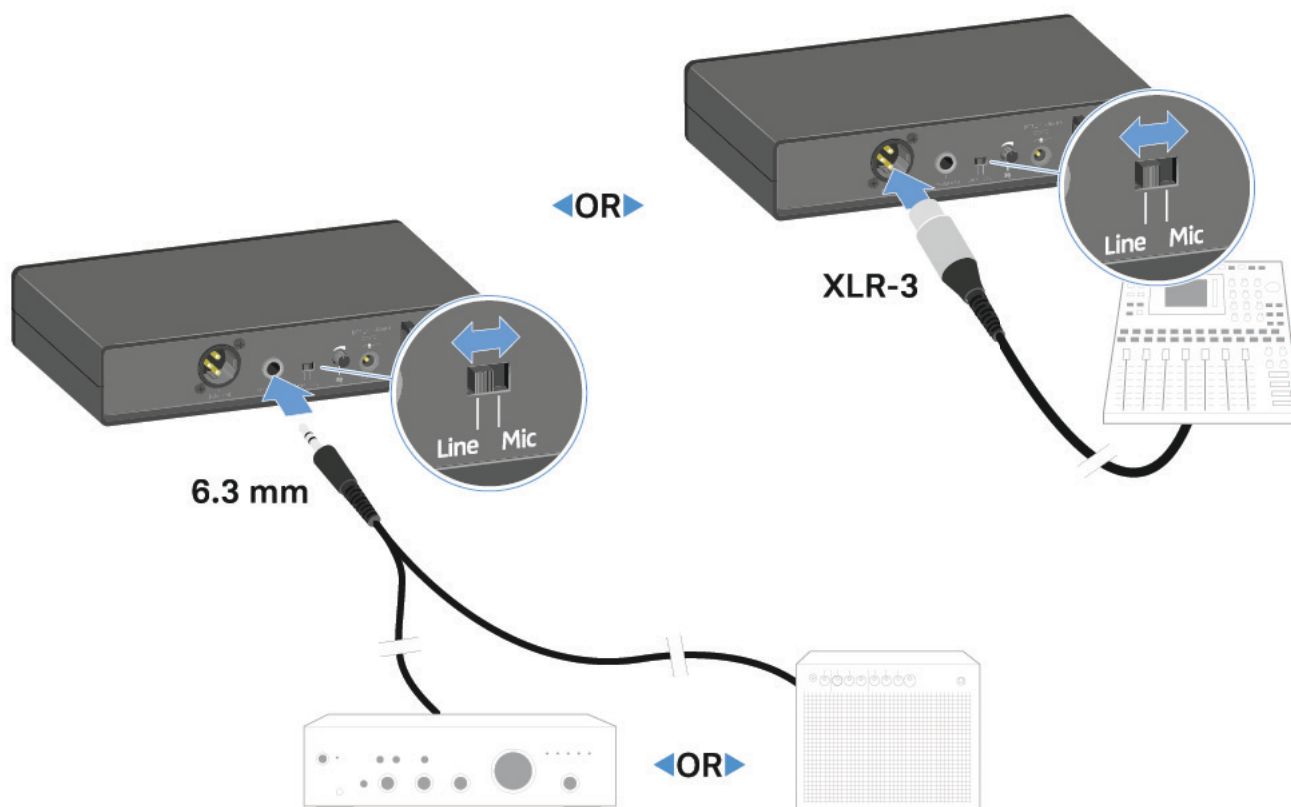

To connect an XLR cable:

- ▷ Plug the XLR cable into the **Balanced** socket on the EM-XSW 1.

To connect a jack cable:

- ▷ Plug the jack cable into the **Unbalanced** socket on the EM-XSW 1.
- ▷ Set the **Line/Mic** switch to the desired position.
  - **Line:** when using instruments or other line sources with the SK-XSW bodypack transmitter
  - **Mic:** when using the SKM 825/835-XSW handheld transmitter or a microphone with the SK-XSW bodypack transmitter



## Switching the receiver on and off

To switch the receiver **on**:

- ▷ Short-press the **ON/OFF** button.  
The receiver switches on.



To switch the receiver to **standby mode**:

- ▷ Hold down the **ON/OFF** button until the display switches off.

To **switch the receiver off completely**:

- ▷ Disconnect the receiver from the power supply system by unplugging the power supply unit from the wall socket.



## Information on the receiver's display

Status information such as frequency, reception quality, battery status and audio level is shown on the display.

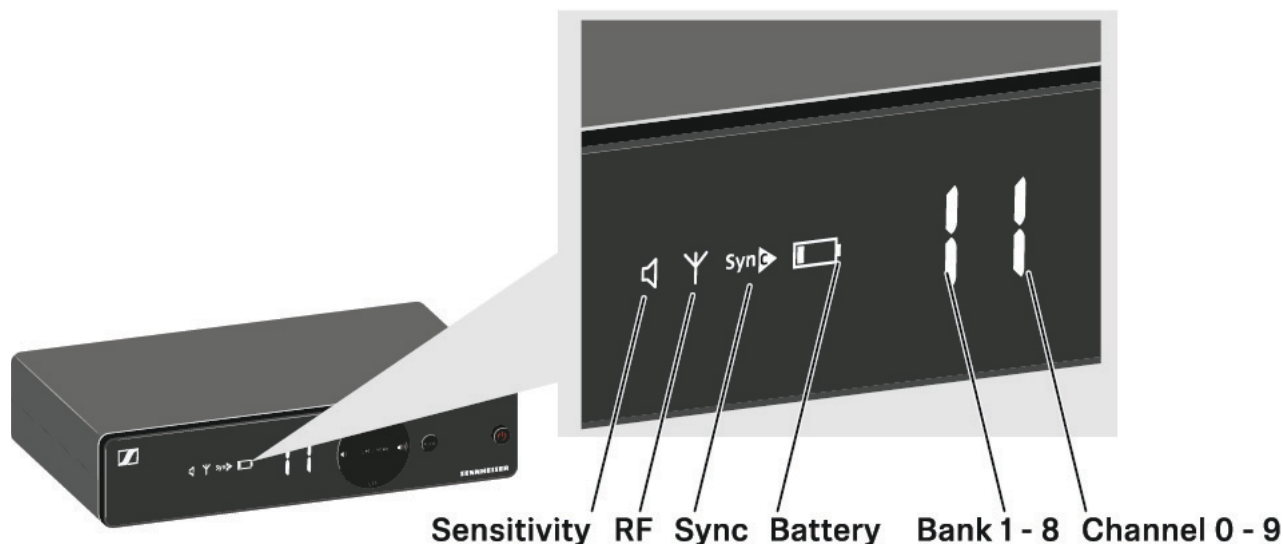

---

### 🔊 **Sensitivity:**

Indicates the sensitivity of the connected transmitter

- SKM: „Setting the input sensitivity“
  - SK: „Setting the input sensitivity“
- 

### 📶 **RF:**

If the antenna symbol is displayed, the radio link is active.

- „Establishing a radio link | Synchronizing the receiver and transmitter“
- 

### 🔄 **Sync:** „Establishing a radio link | Synchronizing the receiver and transmitter“

---



**Battery:**

Battery status of the connected transmitter

- SKM: „Inserting and removing the batteries“
  - SK: „Inserting and removing the batteries“
- 

**Bank/Channel:**

Frequency bank and channel of the radio link

- „Setting options on the front of the device“
-



## Setting options on the front of the device

### Navigation buttons

Use the following buttons to navigate through the receiver's settings.

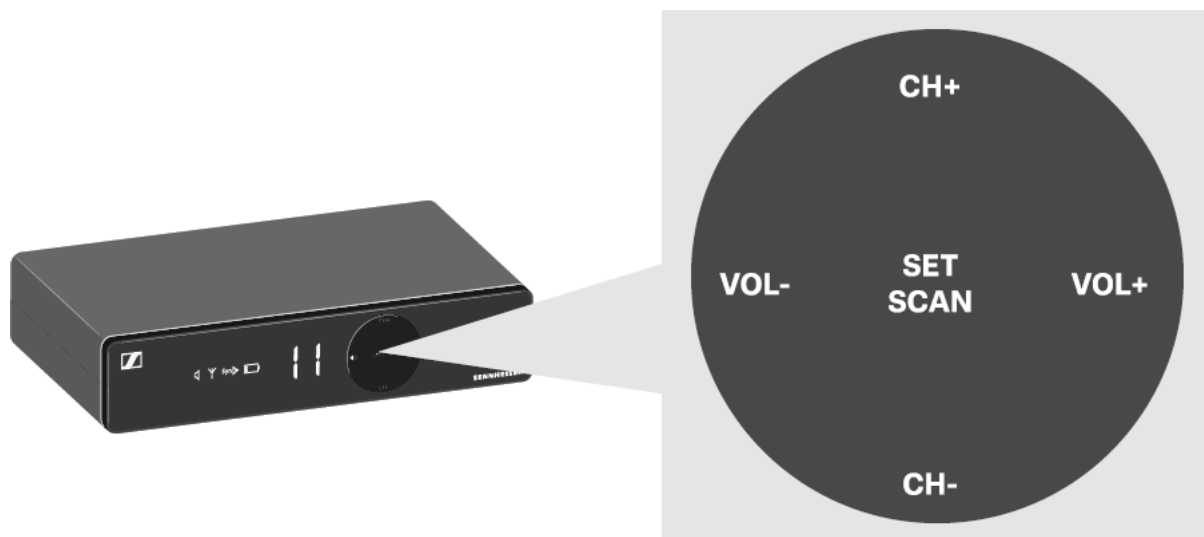

### Setting the frequency automatically (AUTO SCAN)

Performs an automatic frequency scan of your area. This enables you to easily find and assign free radio frequencies.

- ▷ Switch off all transmitters before you perform the scan. If transmitters are still switched on, they are detected as unavailable frequencies and the frequencies that are actually available cannot then be used.
- ▷
- ▷ Press the **SET/SCAN** button for approx. 3 seconds.

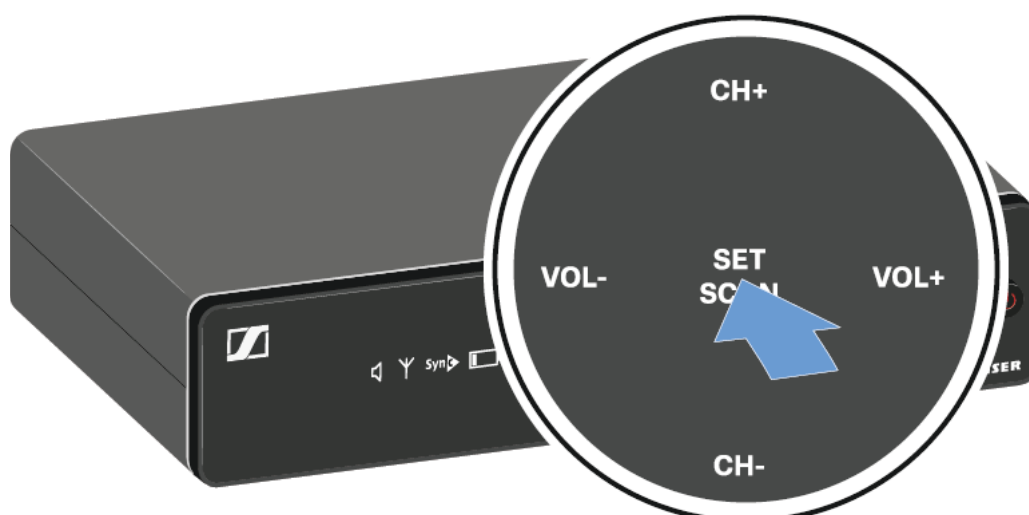



The scan starts automatically. An open channel is then shown in the display (e.g. bank 2, channel 3).

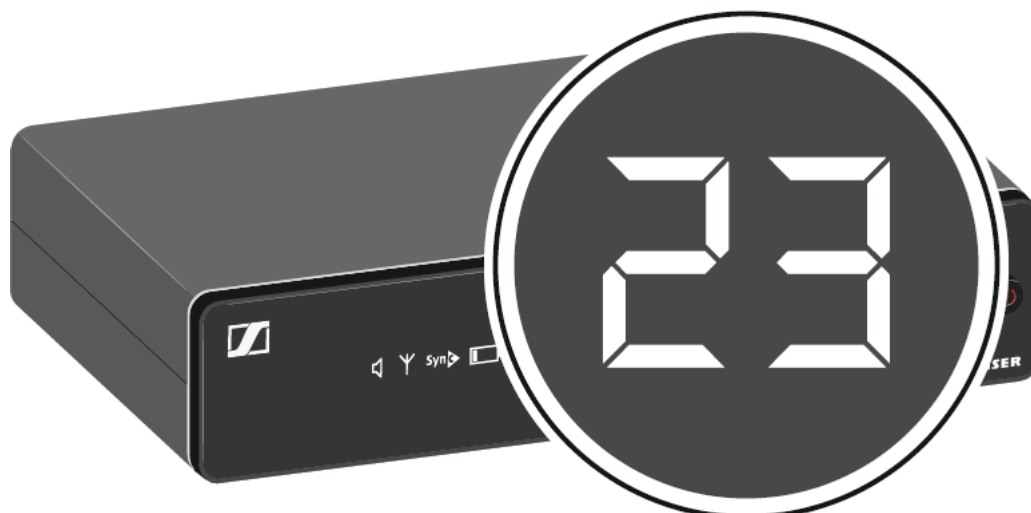

- ▶ Press the **SET/SCAN** button to accept the displayed channel.



If you have set a new frequency, you must still **synchronize** the **receiver** with the **transmitter** to establish the radio link (see „Establishing a radio link | Synchronizing the receiver and transmitter“).

### Setting the frequency manually

- ▶ Press the **SET/SCAN** button.

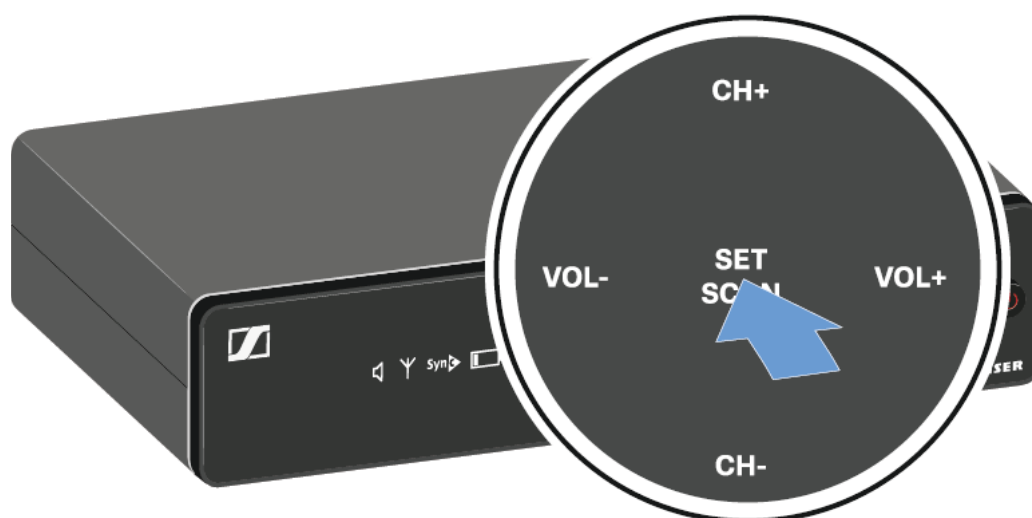



- ▶ Press the **CH+ / CH-** buttons to select a frequency bank (1 to 8).

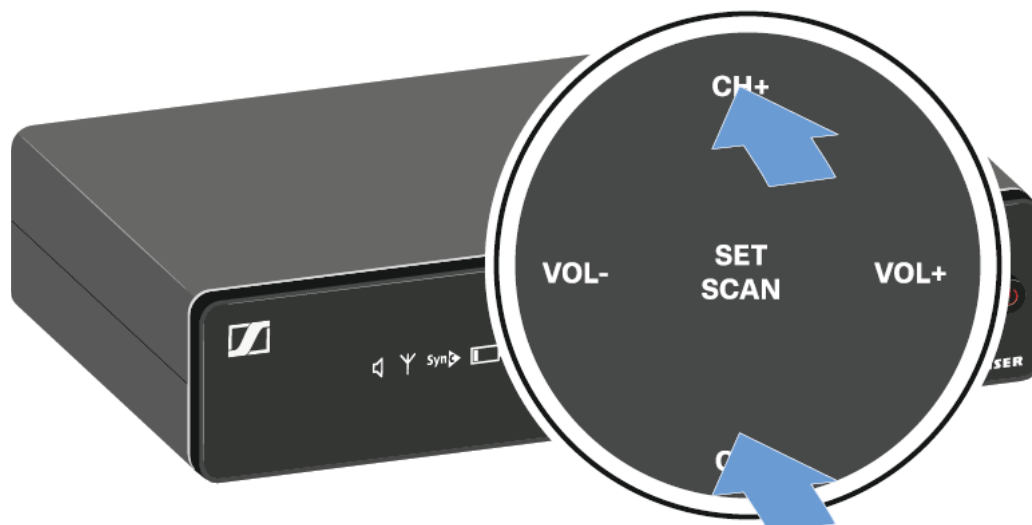

- ▶ Press the **SET/SCAN** button to accept the selected frequency bank.
- ▶ Press the **CH+ / CH-** buttons to select a channel (0 to 9) in the selected frequency bank.  
The selected bank and channel are shown in the display (e.g. bank 2, channel 3).

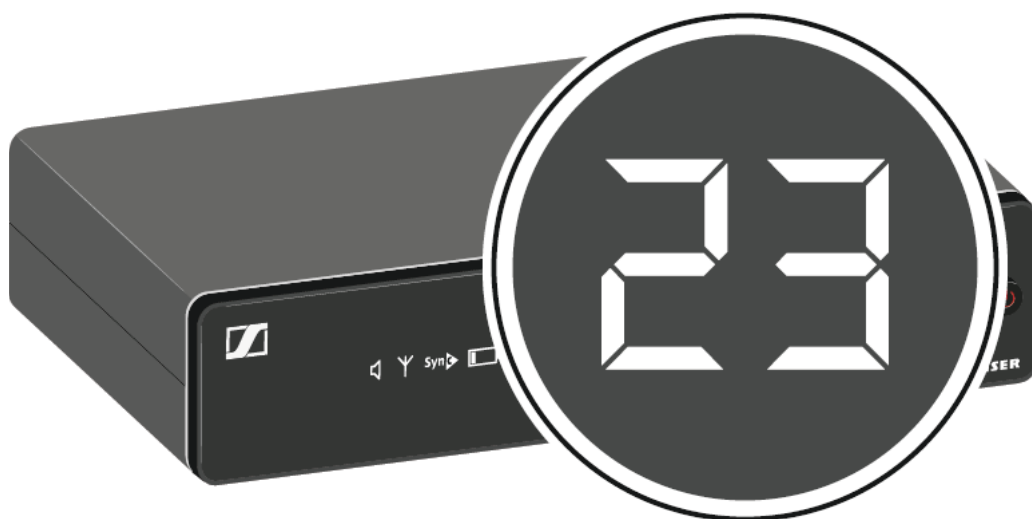

- ▶ Press the **SET/SCAN** button to accept the selected channel.



If you have set a new frequency, you must still **synchronize** the **receiver** with the **transmitter** to establish the radio link (see „Establishing a radio link | Synchronizing the receiver and transmitter“).



## Adjusting the volume of the audio outputs

Use the **VOL+**/**VOL-** buttons to set the level of the audio signal coming from the receiver's audio outputs (**Balanced/Unbalanced**). This audio signal can be output to a mixing console or an amplifier, for example.

- ▷ Press the **VOL+**/**VOL-** buttons to adjust the volume.

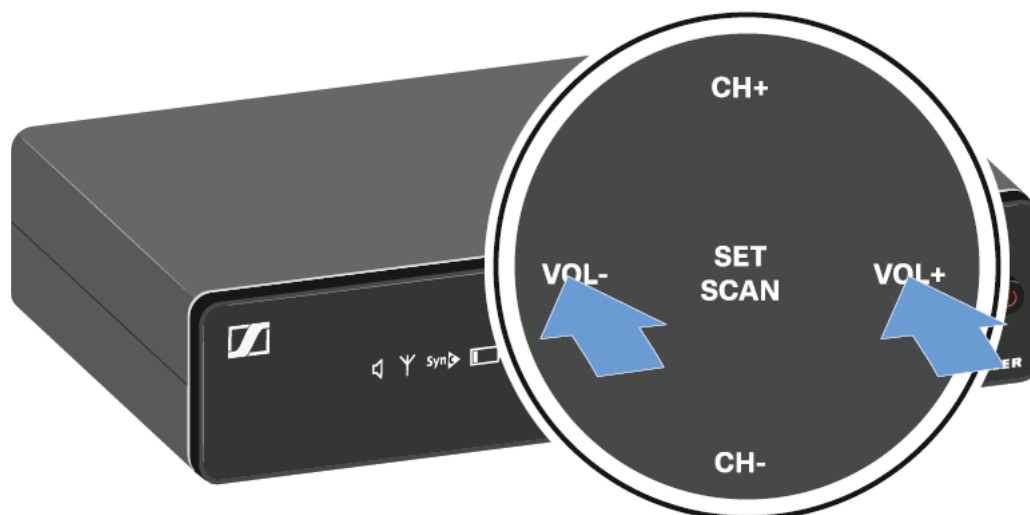

- ▷ Make sure that the signal in the next device in the signal chain (e.g. mixing console, power amplifier, guitar amplifier, etc.) is not overdriven.



## Setting options on the rear of the device

### Selecting the signal type (Mic/Line)



- ▷ Set the **Line/Mic** switch to the desired position.
  - **Line:** when using instruments or other line sources with the SK-XSW bodypack transmitter
  - **Mic:** when using the SKM-XSW handheld transmitter or a microphone with the SK-XSW bodypack transmitter

### Setting the squelch

The squelch function can be used to suppress disturbing noise during transmission, such as hiss. If the signal level is below the squelch threshold, the signal is muted.

If the squelch threshold is set very high, this will shorten the radio range.



- ▷ Turn the control knob to the left or right to adjust the squelch.



## Configuring a multi-channel system

Please note when creating multi-channel systems:

Only the factory-preset transmission frequencies within one frequency bank are intermodulation-free.

- ▷ Set the same channel bank for all receivers.
- ▷ Assign one channel from this channel bank to each receiver.

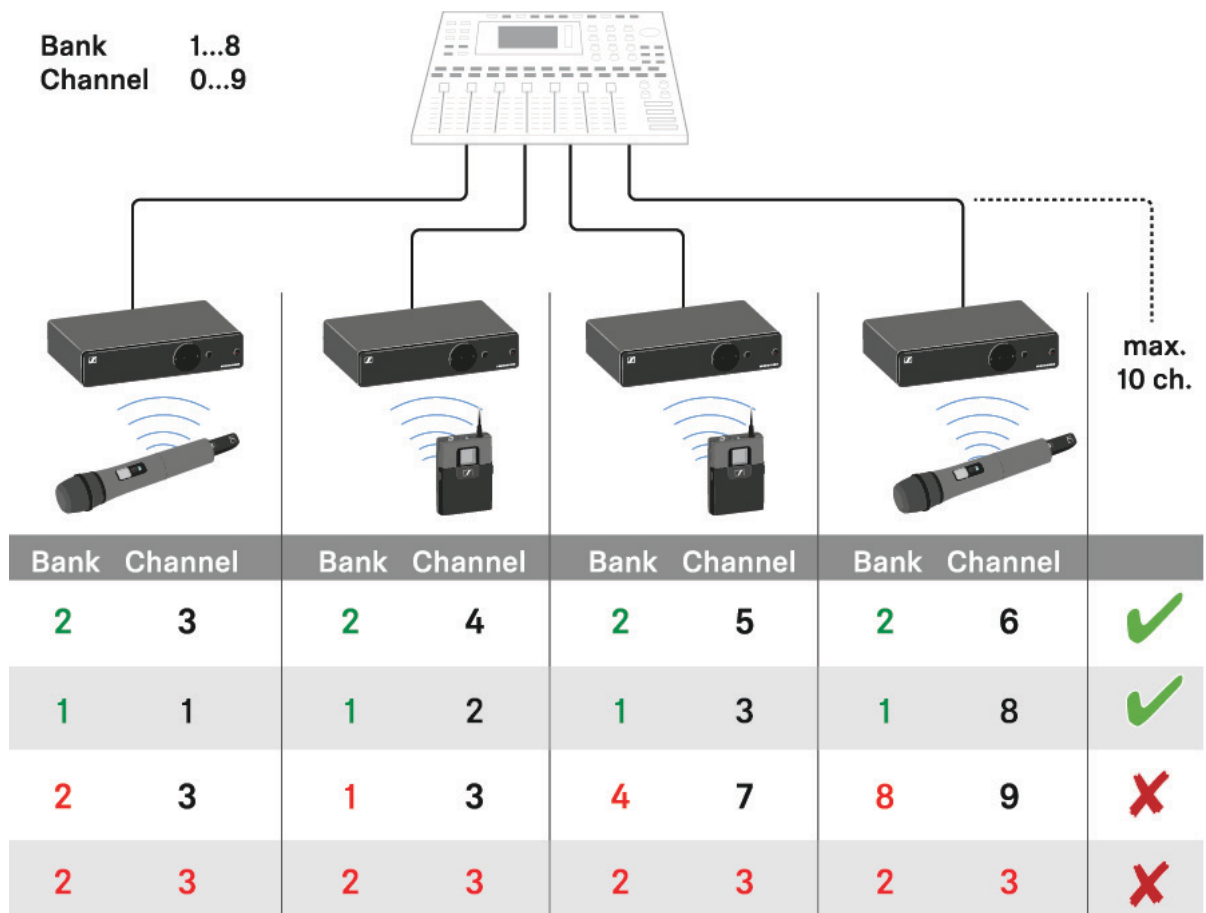

We recommend using the **AUTO SCAN** function, as this is the most reliable way to identify free frequencies (see „Setting the frequency automatically (AUTO SCAN)“).

If you know free frequencies in your area, you can also set the frequency manually (see „Setting the frequency manually“).



# EM-XSW 1 DUAL rack receiver

## Connectors and controls

The EM-XSW 1 DUAL two-channel receiver is essentially two individual EM-XSW 1 receivers in one housing.

Each of the two receiver channels has separate connectors and setting options.

### Front

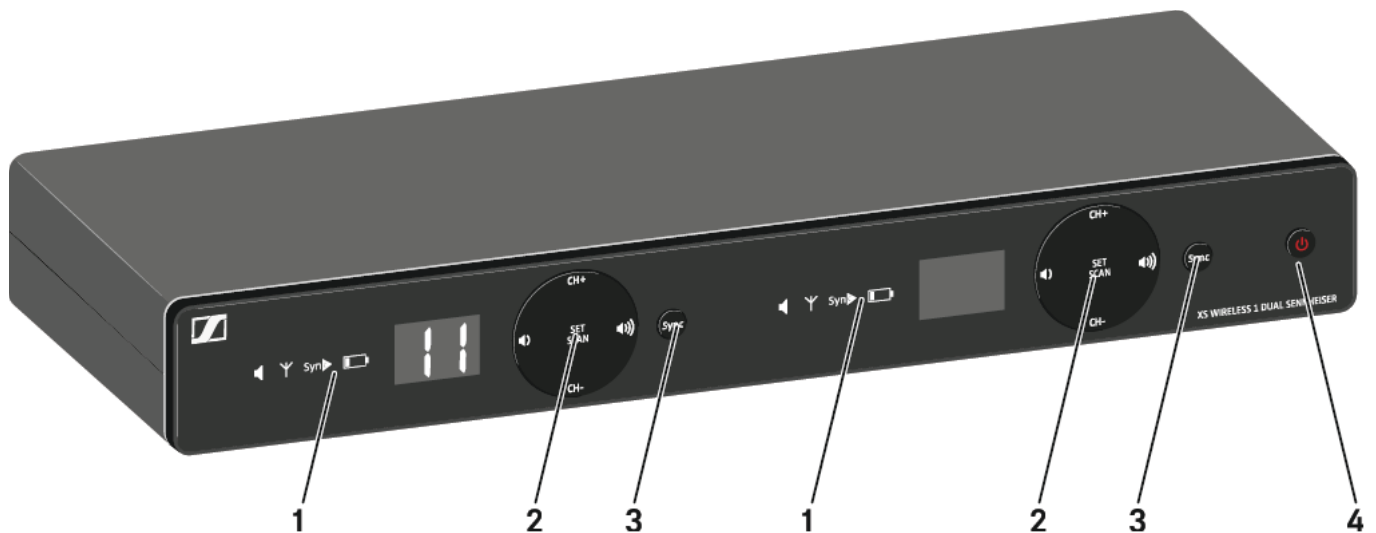

- 1** Display for status information
  - For each of the two channels
  - See „Information on the receiver’s display“
- 2** Control buttons for selecting channels and adjusting volume
  - For each of the two channels
  - See „Setting options on the front of the device“
- 3** **SYNC** button for synchronizing the transmitter and receiver
  - For each of the two channels
  - See „Establishing a radio link | Synchronizing the receiver and transmitter“
- 4** **ON/OFF** button for switching the device on and off
  - See „Switching the receiver on and off“





## Back

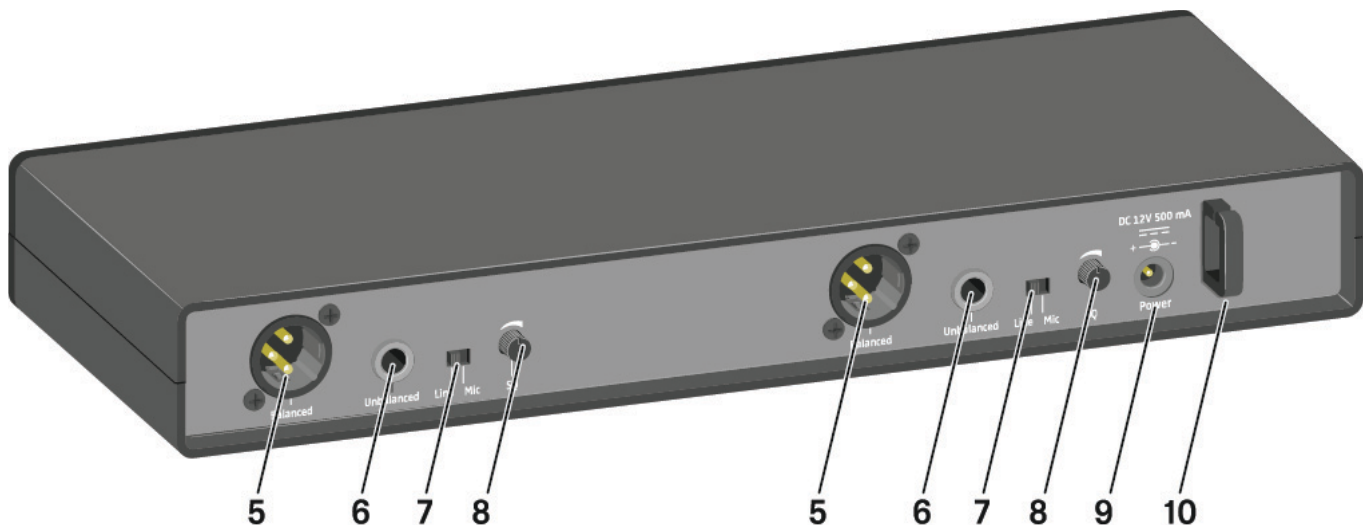

- 5** XLR-3 socket for **Balanced** audio output
  - For each of the two channels
  - See „Outputting audio signals“
- 6** 6.3 mm jack socket for **Unbalanced** audio output
  - For each of the two channels
  - See „Outputting audio signals“
- 7** **Line/Mic** switch for selecting the signal type
  - For each of the two channels
  - See „Setting options on the rear of the device“
  - See „Outputting audio signals“
- 8** SQ control knob for adjusting the squelch value
  - For each of the two channels
  - See „Setting options on the rear of the device“
- 9** **Power** connection socket for the power supply unit
  - See „Connecting/disconnecting the receiver to/from the power supply system“
- 10** Strain relief for the connection cable of the power supply unit
  - See „Connecting/disconnecting the receiver to/from the power supply system“



## Connecting/disconnecting the receiver to/from the power supply system

Only use the supplied power supply unit. It is designed for your receiver and ensures safe operation.

To connect the receiver to the power supply system:

- ▷ Pass the cable of the power supply unit through the strain relief.
- ▷ Insert the plug of the power supply unit into the **Power** socket on the receiver.
- ▷ Slide the supplied country adapter onto the power supply unit.
- ▷ Plug the power supply unit into the wall socket.

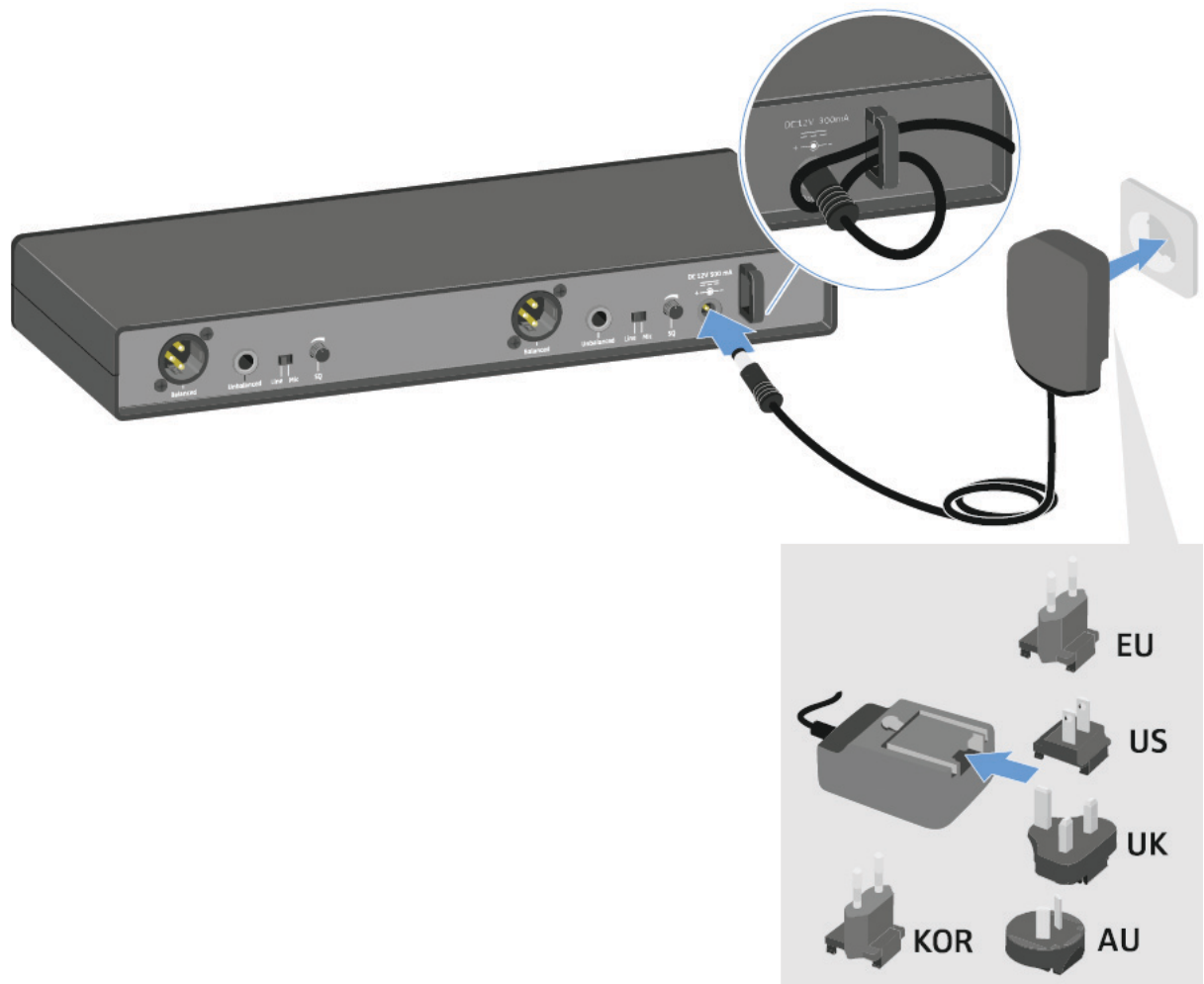

To completely disconnect the receiver from the power supply system:

- ▷ Unplug the power supply unit from the wall socket.
- ▷ Unplug the power supply unit from the **Power** socket on the receiver.



## Outputting audio signals

Each of the two channels on the EM-XSW1 DUAL has both a balanced XLR-3M output socket and an unbalanced 6.3 mm (1/4") jack output socket.

The EM-XSW 1 has a balanced XLR-3M output socket and an unbalanced 6.3 mm jack output socket.

- ▷ Always use only one of the two output sockets for each channel.

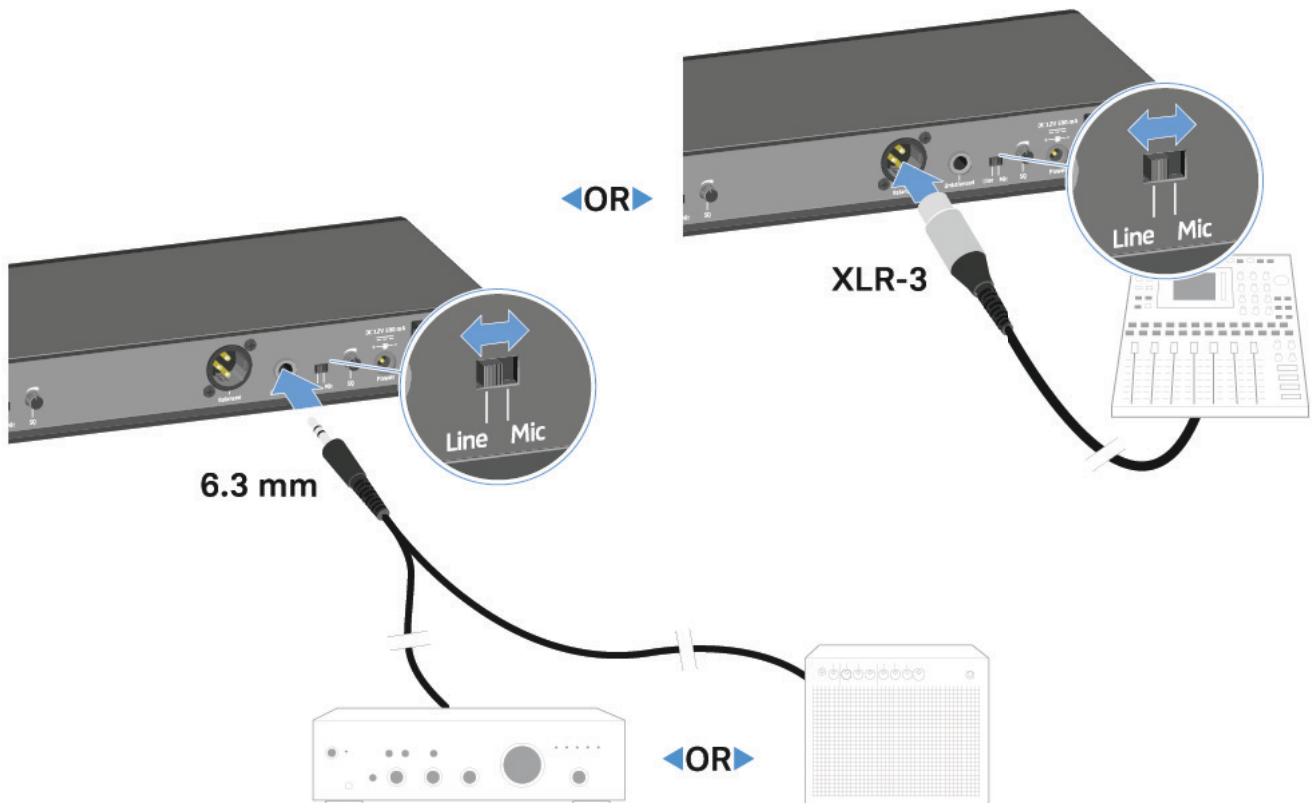

To connect an XLR cable:

- ▷ Plug the XLR cable into the **Balanced** socket for the respective channel on the EM-XSW 1 DUAL.

To connect a jack cable:

- ▷ Plug the jack cable into the **Unbalanced** socket for the respective channel on the EM-XSW 1 DUAL.
- ▷ Set the **Line/Mic** switch to the desired position for each of the two channels.
  - **Line:** when using instruments or other line sources with the SK-XSW bodypack transmitter
  - **Mic:** when using the SKM 825/835-XSW handheld transmitter or a microphone with the SK-XSW bodypack transmitter



## Switching the receiver on and off

To switch the receiver **on**:

- ▷ Short-press the **ON/OFF** button.  
The receiver switches on.



To switch the receiver to **standby mode**:

- ▷ Hold down the **ON/OFF** button until the display switches off.

To **switch the receiver off completely**:

- ▷ Disconnect the receiver from the power supply system by unplugging the power supply unit from the wall socket.



## Information on the receiver's display

Status information such as frequency, reception quality, battery status and audio level is shown on the display for each of the two channels.

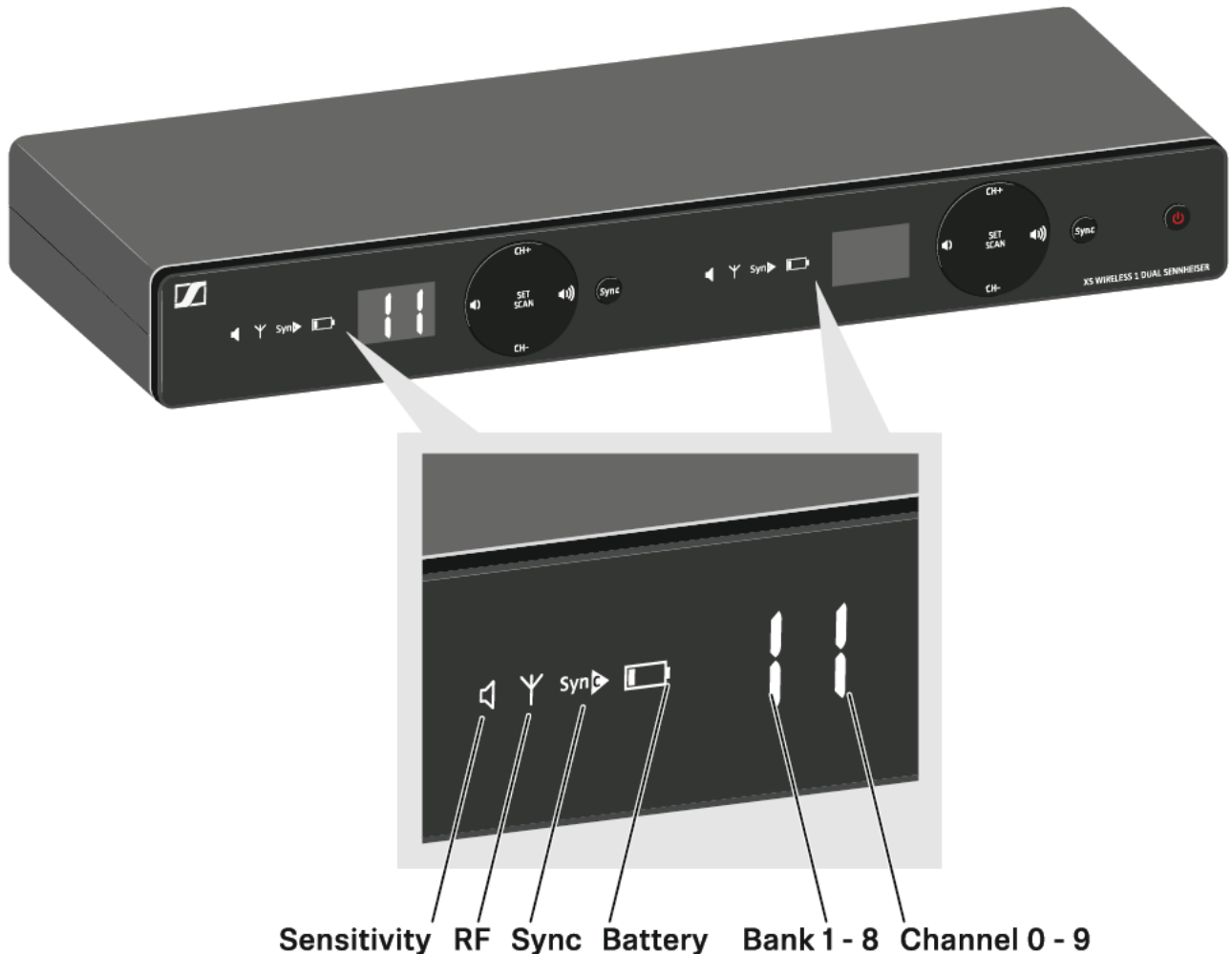

### 🔊 Sensitivity:

Indicates the sensitivity of the connected transmitter

- SKM: „Setting the input sensitivity“
- SK: „Setting the input sensitivity“

### Y RF:

If the antenna symbol is displayed, the radio link is active.

- „Establishing a radio link | Synchronizing the receiver and transmitter“



---

**Sync** ▶ **Sync:** „Establishing a radio link | Synchronizing the receiver and transmitter“

---

**Battery:**

Battery status of the connected transmitter

- SKM: „Inserting and removing the batteries“
  - SK: „Inserting and removing the batteries“
- 

**Bank/Channel:**

- || Frequency bank and channel of the radio link
- „Setting options on the front of the device“
-



## Setting options on the front of the device

### Navigation buttons

Use the following buttons to navigate through the receiver's settings.



### Setting the frequency automatically (AUTO SCAN)

Performs an automatic frequency scan of your area. This enables you to easily find and assign free radio frequencies.

- ▷ Switch off all transmitters before you perform the scan. If transmitters are still switched on, they are detected as unavailable frequencies and the frequencies that are actually available cannot then be used.



- ▶ Press the **SET/SCAN** button for approx. 3 seconds.

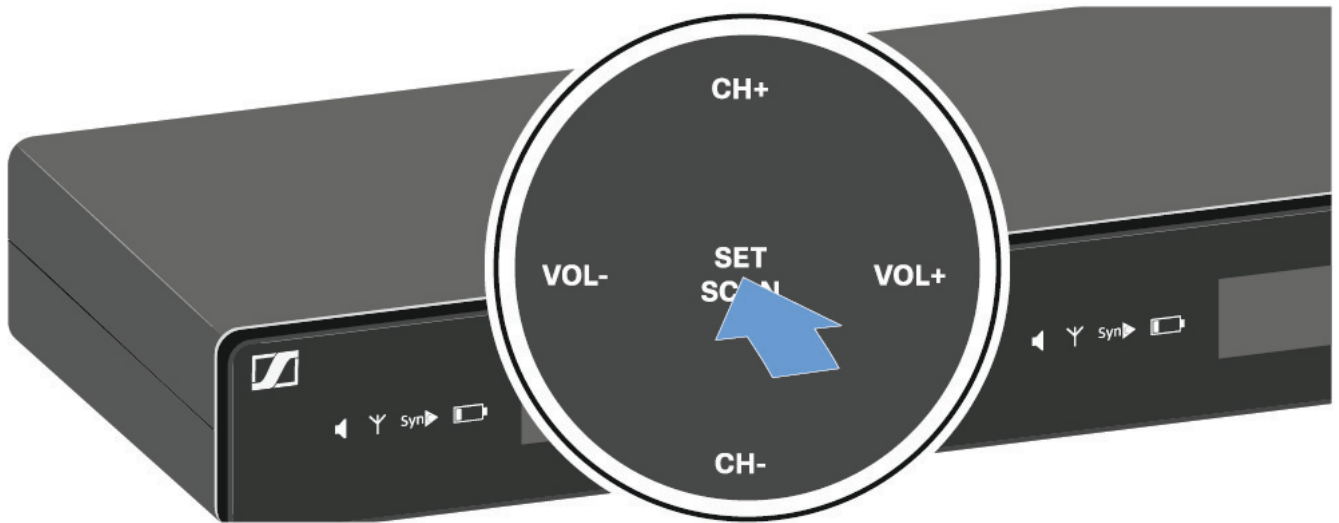

The scan starts automatically. An open channel is then shown in the display (e.g. bank 2, channel 3).



- ▶ Press the **SET/SCAN** button to accept the displayed channel.



If you have set a new frequency, you must still **synthesize** the **receiver** with the **transmitter** to establish the radio link (see „Establishing a radio link | Synchronizing the receiver and transmitter“).





## Setting the frequency manually

- ▷ Press the **SET/SCAN** button.

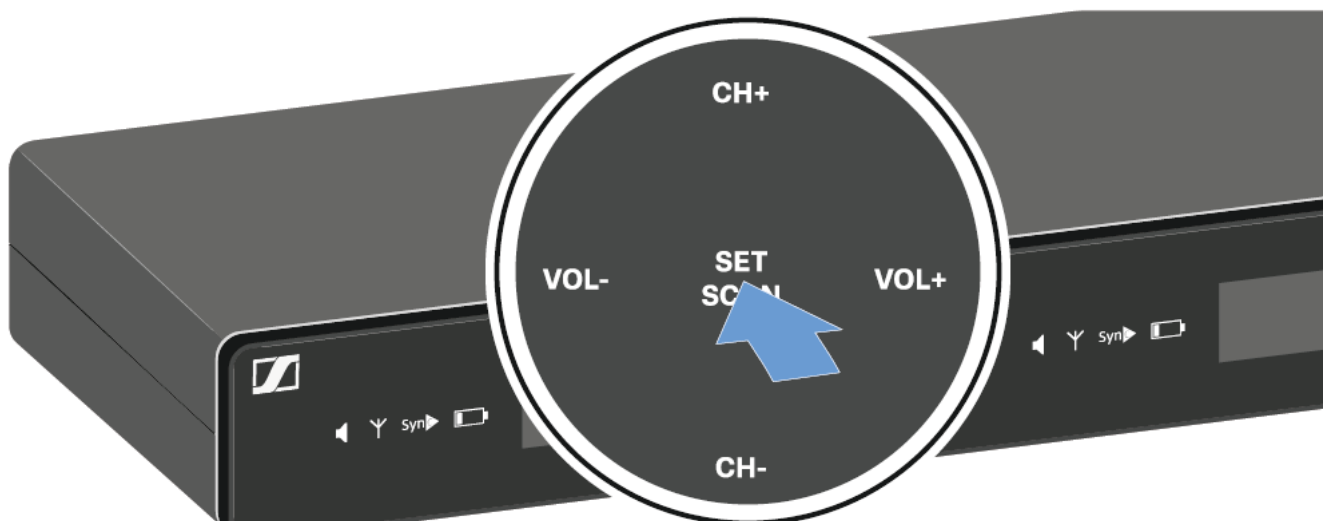

- ▷ Press the **CH+/CH-** buttons to select a frequency bank (1 to 8).

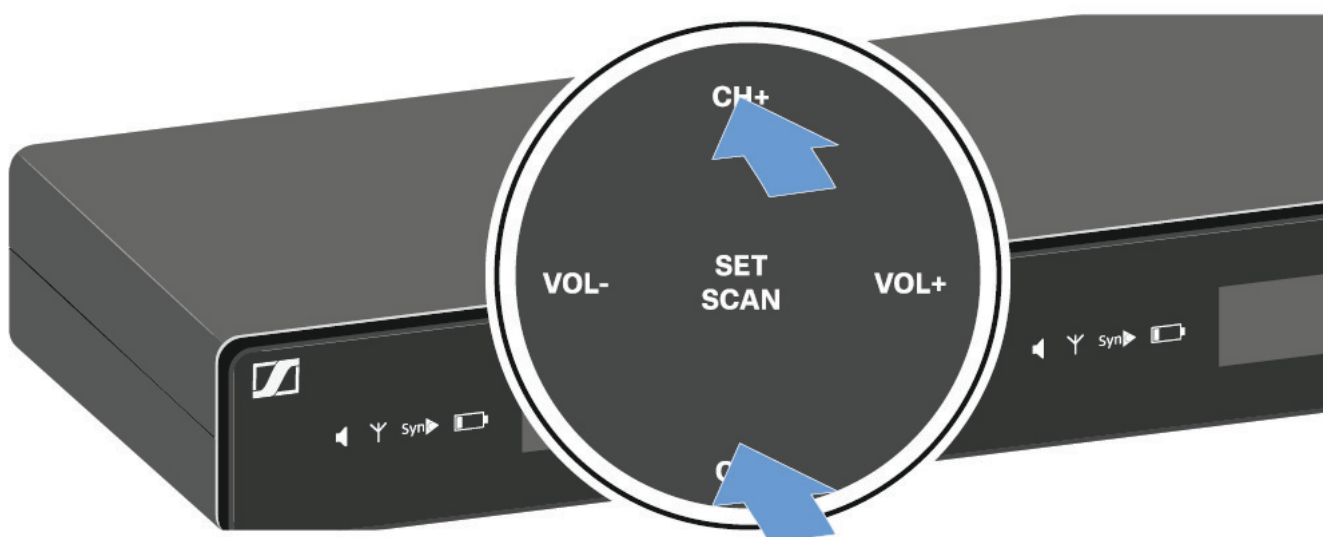

- ▷ Press the **SET/SCAN** button to accept the selected frequency bank.



- ▶ Press the **CH+ / CH-** buttons to select a channel (0 to 9) in the selected frequency bank.

The selected bank and channel are shown in the display (e.g. bank 2, channel 3).



- ▶ Press the **SET/SCAN** button to accept the selected channel.



If you have set a new frequency, you must still **synchronize** the **receiver** with the **transmitter** to establish the radio link (see „Establishing a radio link | Synchronizing the receiver and transmitter“).



## Adjusting the volume of the audio outputs

Use the **VOL+**/**VOL-** buttons to set the level of the audio signal coming from the receiver's audio outputs (**Balanced/Unbalanced**). This audio signal can be output to a mixing console or an amplifier, for example.

- ▷ Press the **VOL+**/**VOL-** buttons to adjust the volume.

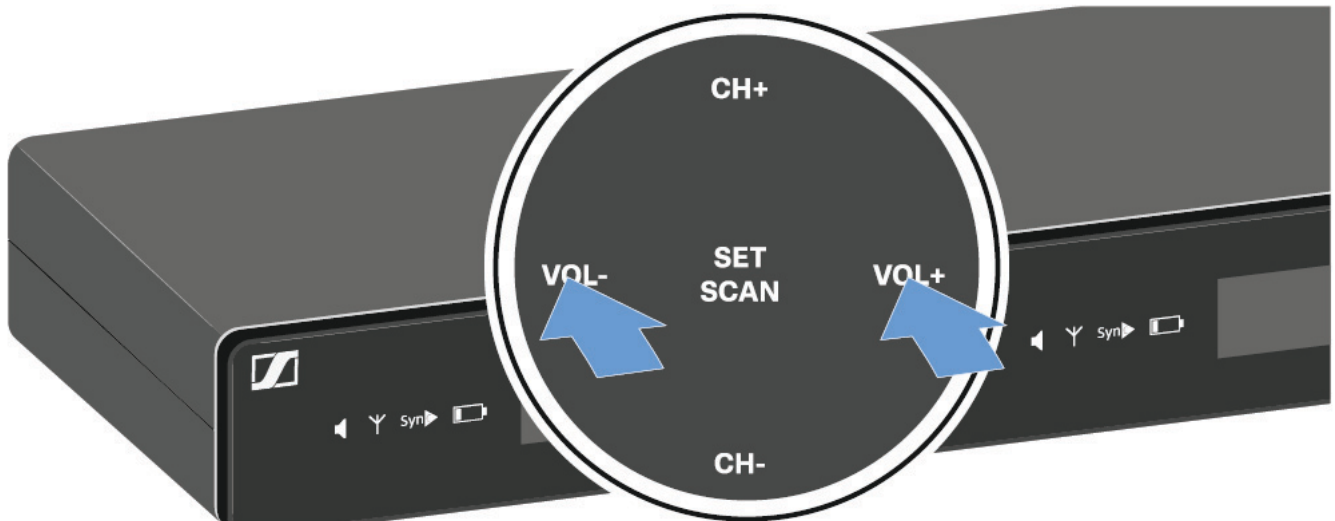

- ▷ Make sure that the signal in the next device in the signal chain (e.g. mixing console, power amplifier, guitar amplifier, etc.) is not overdriven.



## Setting options on the rear of the device

### Selecting the signal type (Mic/Line)

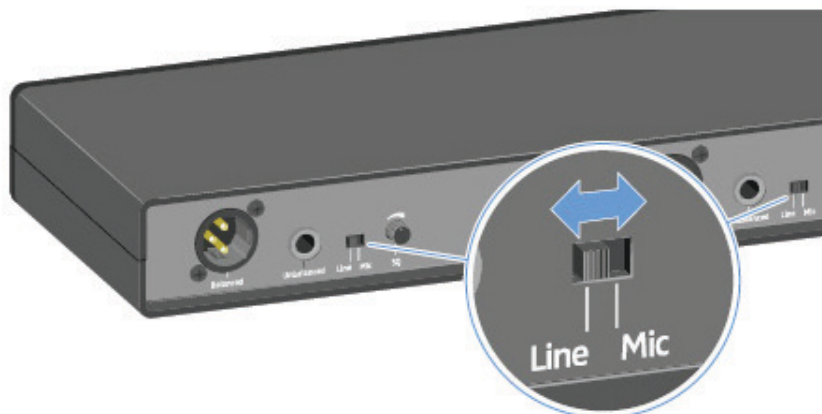

- ▷ Set the **Line/Mic** switch to the desired position for each of the two channels.
  - **Line:** when using instruments or other line sources with the SK-XSW bodypack transmitter
  - **Mic:** when using the SKM-XSW handheld transmitter or a microphone with the SK-XSW bodypack transmitter

### Setting the squelch

The squelch function can be used to suppress disturbing noise during transmission, such as hiss. If the signal level is below the squelch threshold, the signal is muted.

If the squelch threshold is set very high, this will shorten the radio range.

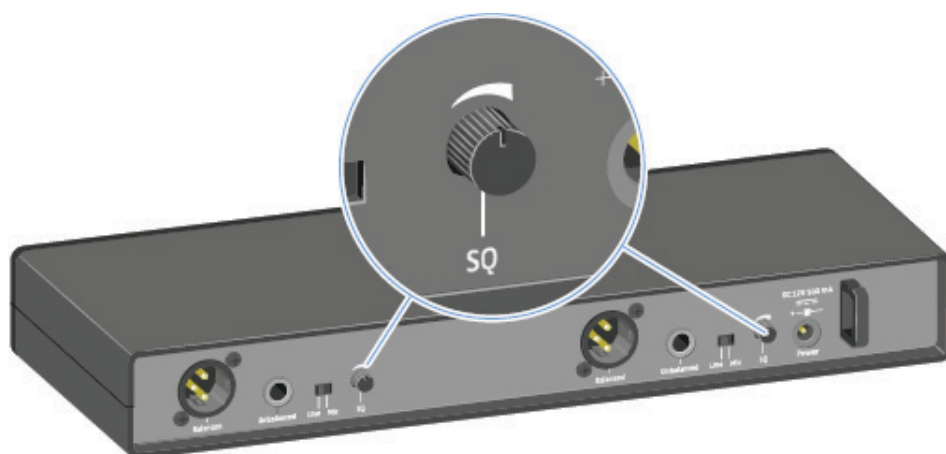

- ▷ Turn the control knob to the left or right to adjust the squelch.



## Configuring a multi-channel system

Please note when creating multi-channel systems:

Only the factory-preset transmission frequencies within one frequency bank are intermodulation-free.

- ▷ Set the same channel bank for all receivers.
- ▷ Assign one channel from this channel bank to each receiver.

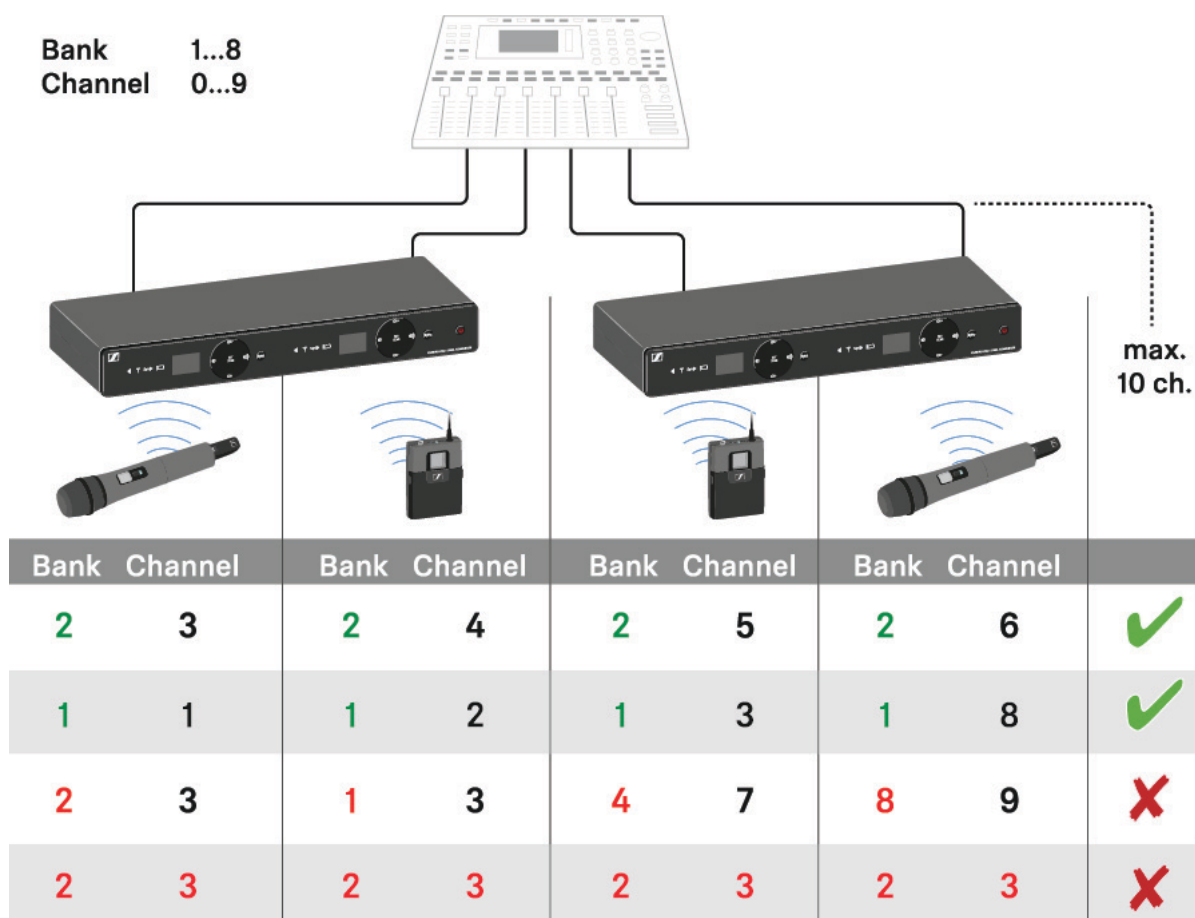

We recommend using the **AUTO SCAN** function, as this is the most reliable way to identify free frequencies (see „Setting the frequency automatically (AUTO SCAN)“).

If you know free frequencies in your area, you can also set the frequency manually (see „Setting the frequency manually“).



## EM-XSW 2 rack receiver

### Connectors and controls

#### Front



- 1** Display for status information
  - See „Information on the receiver’s display“
- 2** **UP/DOWN** menu buttons for navigating the operating menu
  - See „Setting options on the front of the device“
- 3** **SET** menu button for navigating the operating menu
  - See „Setting options on the front of the device“
- 4** **SYNC** button for synchronizing the transmitter and receiver
  - See „Establishing a radio link | Synchronizing the receiver and transmitter“
- 5** Control knob for adjusting the volume
  - See „Adjusting the volume of the audio outputs“
- 6** **ON/OFF** button for switching the device on and off and canceling an action in the menu
  - See „Switching the receiver on and off“
  - See „Setting options on the front of the device“



## Back

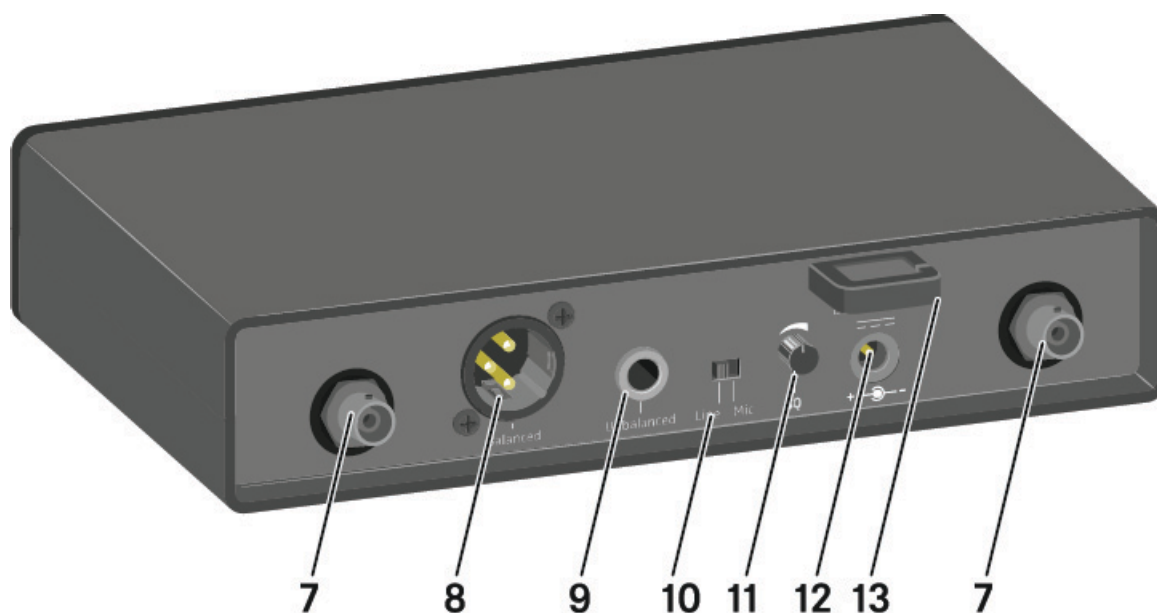

- 7** BNC sockets, antenna inputs
  - See „Connecting antennas“
- 8** XLR-3 socket for **Balanced** audio output
  - See „Outputting audio signals“
- 9** 6.3 mm jack socket for **Unbalanced** audio output
  - See „Outputting audio signals“
- 10** **Line/Mic** switch for selecting the signal type
  - See „Setting options on the rear of the device“
  - See „Outputting audio signals“
- 11** SQ control knob for adjusting the squelch value
  - See „Setting options on the rear of the device“
- 12** **Power** connection socket for the power supply unit
  - See „Connecting/disconnecting the receiver to/from the power supply system“
- 13** Strain relief for the connection cable of the power supply unit
  - See „Connecting/disconnecting the receiver to/from the power supply system“



## Connecting/disconnecting the receiver to/from the power supply system

Only use the supplied power supply unit. It is designed for your receiver and ensures safe operation.

To connect the receiver to the power supply system:

- ▷ Pass the cable of the power supply unit through the strain relief.
- ▷ Insert the plug of the power supply unit into the **Power** socket on the receiver.
- ▷ Slide the supplied country adapter onto the power supply unit.
- ▷ Plug the power supply unit into the wall socket.

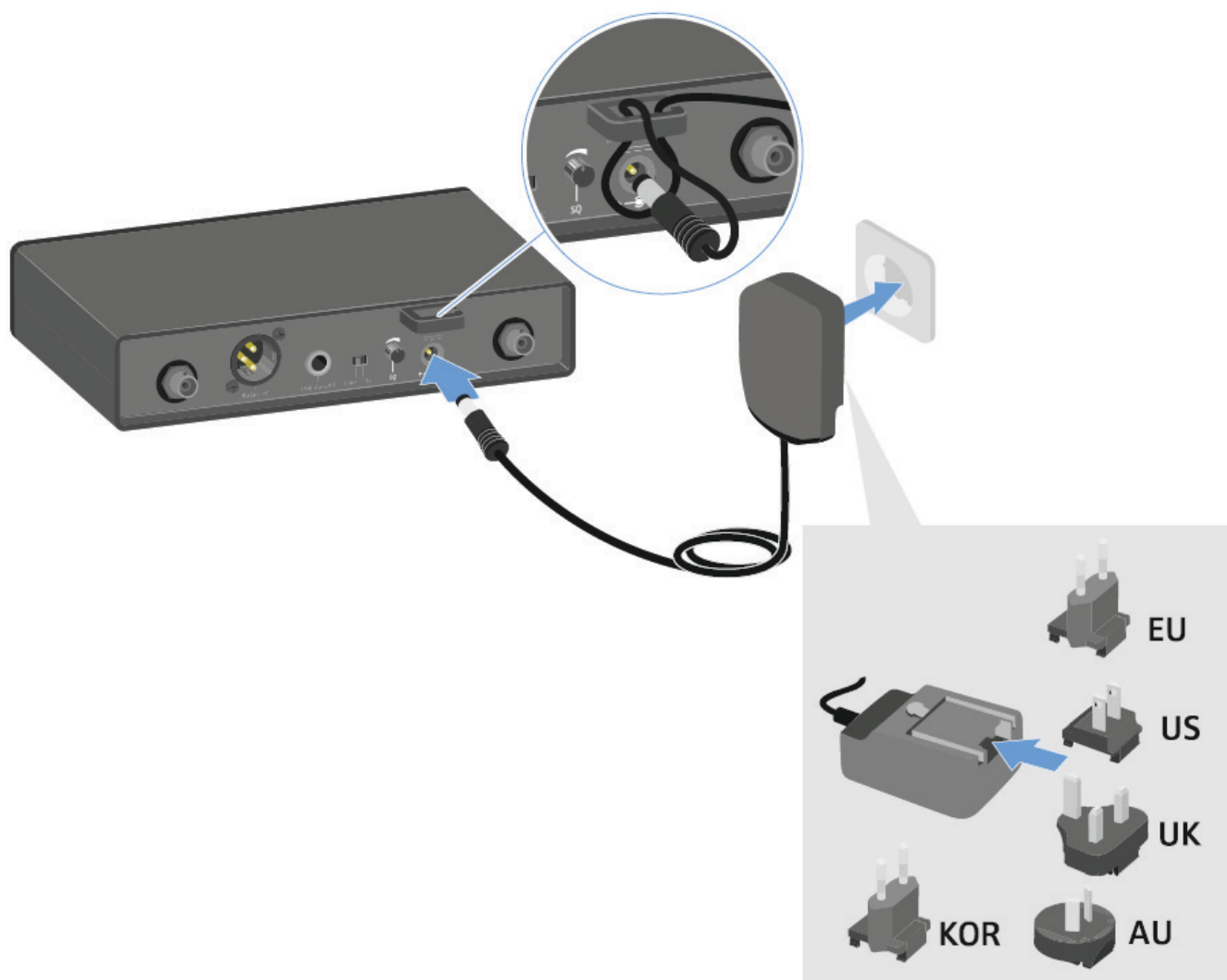

To completely disconnect the receiver from the power supply system:

- ▷ Unplug the power supply unit from the wall socket.
- ▷ Unplug the power supply unit from the **Power** socket on the receiver.





## Connecting antennas

To connect the supplied rod antennas:



- ▷ Connect the antennas to the two antenna inputs on the receiver as shown in the figure.
- ▷ Slightly angle the antennas to the left and right as shown in the figure.



## Outputting audio signals

The EM-XSW 2 has a balanced XLR-3M output socket and an unbalanced 6.3 mm jack output socket.

- ▷ Always use only one of the two output sockets.

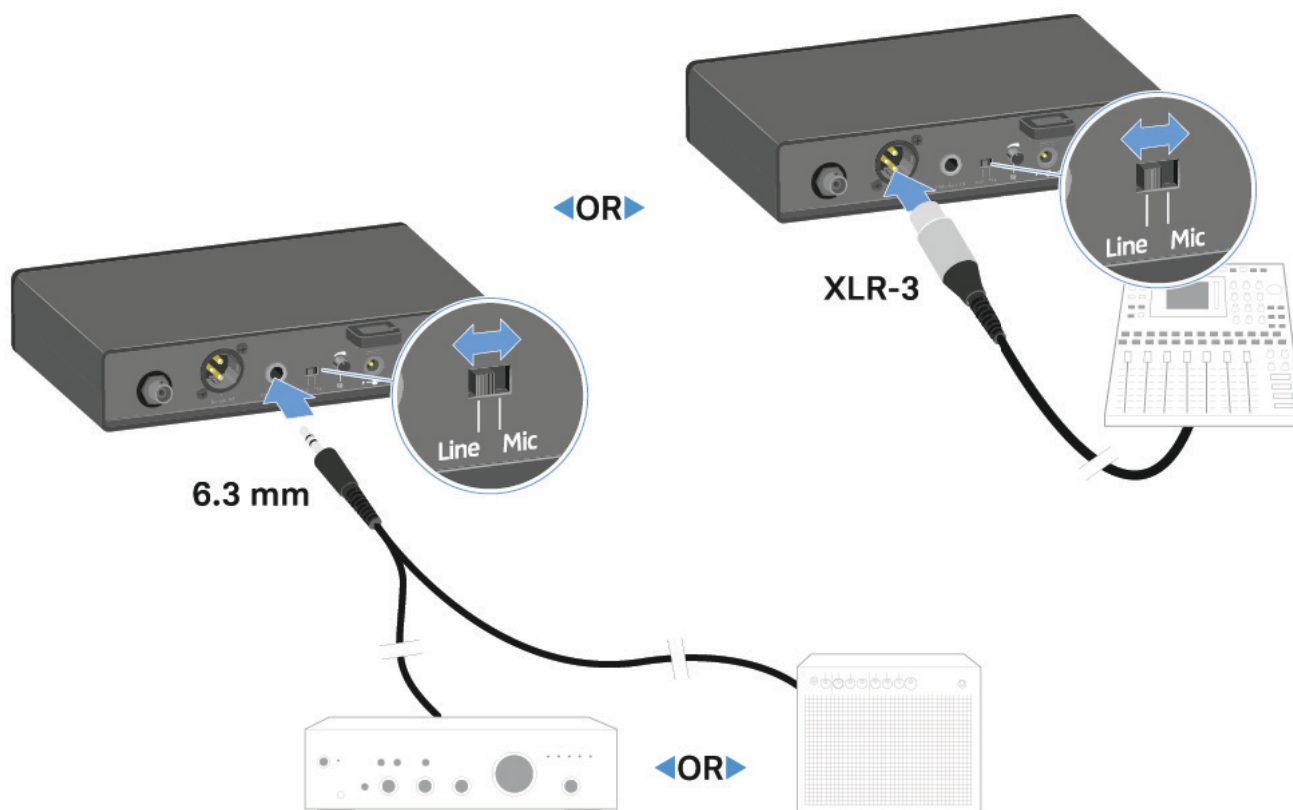

To connect an XLR cable:

- ▷ Plug the XLR cable into the **Balanced** socket on the EM-XSW 2.

To connect a jack cable:

- ▷ Plug the jack cable into the **Unbalanced** socket on the EM-XSW 2.
- ▷ Set the **Line/Mic** switch to the desired position.
  - **Line:** when using instruments or other line sources with the SK-XSW bodypack transmitter
  - **Mic:** when using the SKM 835/865-XSW handheld transmitter or a microphone with the SK-XSW bodypack transmitter



## Installing receivers in a rack

---

### CAUTION

#### **Rack mounting poses risks**

When installing the device in a closed 19" rack or multi-rack assembly, please consider that, during operation, the ambient temperature, the mechanical load and the electrical potentials will be different from those of devices which are not mounted into a rack.

- ▷ Make sure that the ambient temperature within the rack does not exceed the permissible temperature limit stated in the specifications. See „SPECIFICATIONS“.
- ▷ Ensure sufficient ventilation; if necessary, provide additional ventilation.
- ▷ Make sure that the mechanical load of the rack is even.
- ▷ When connecting to the power supply system, observe the information indicated on the type plate. Avoid overloading the circuits. If necessary, provide overcurrent protection.
- ▷ When mounting in a rack, please note that intrinsically harmless leakage currents of the individual power supply units may accumulate, thereby exceeding the permissible limit value. As a remedy, ground the rack via an additional ground connection.

---

To mount the receiver in a rack, you will need the GA 1-XSW 2 rack mount kit (see „Accessories“).



## Mounting a single receiver in a rack

- ▷ Connect the mounting brackets to the sides of the receiver as shown in the figure.

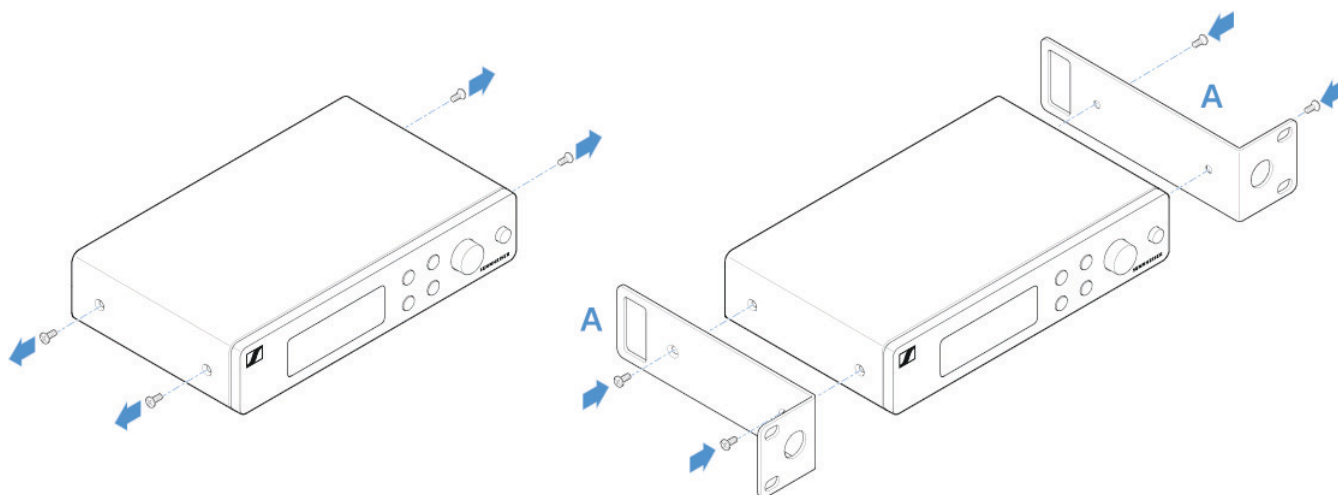

- ▷ Attach the front panel as shown in the figure.
- ▷ If desired, attach the antennas to the front panel as shown in the figure.

This requires the optional GA 2-XSW 2 antenna front mount kit (see „Accessories“).

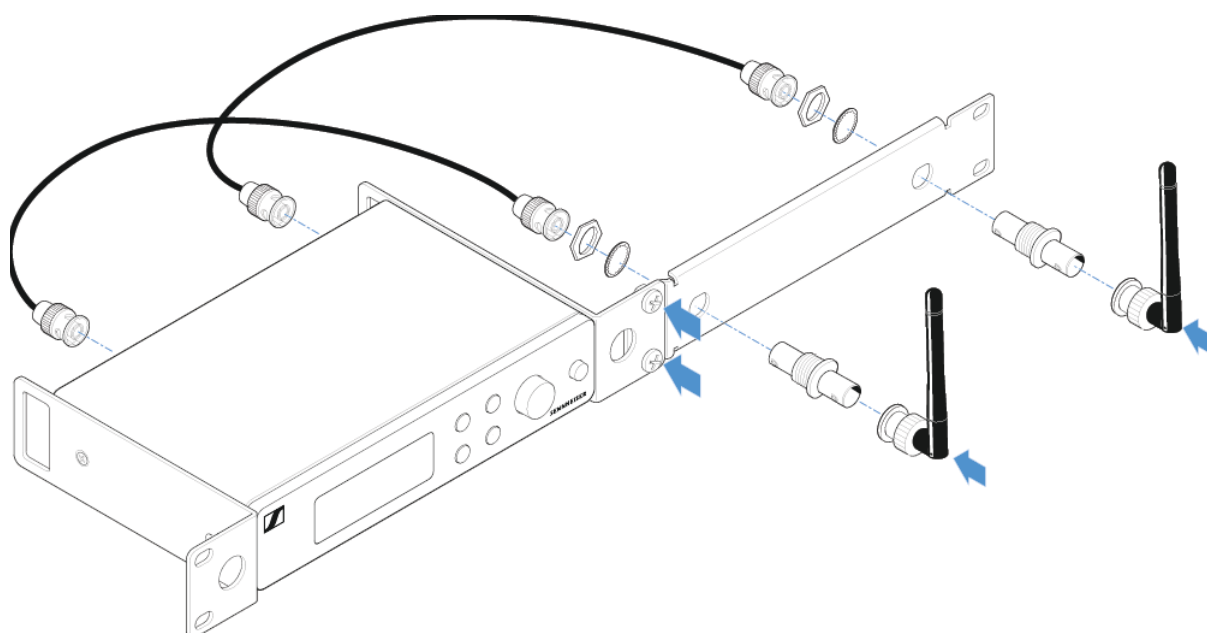



## Mounting two receivers side by side in a rack

- ▷ Place both receivers upside down and side by side on an even surface.
- ▷ Tighten the jointing plate as shown in the figure.
- ▷ Attach the mounting brackets as shown in the figure.

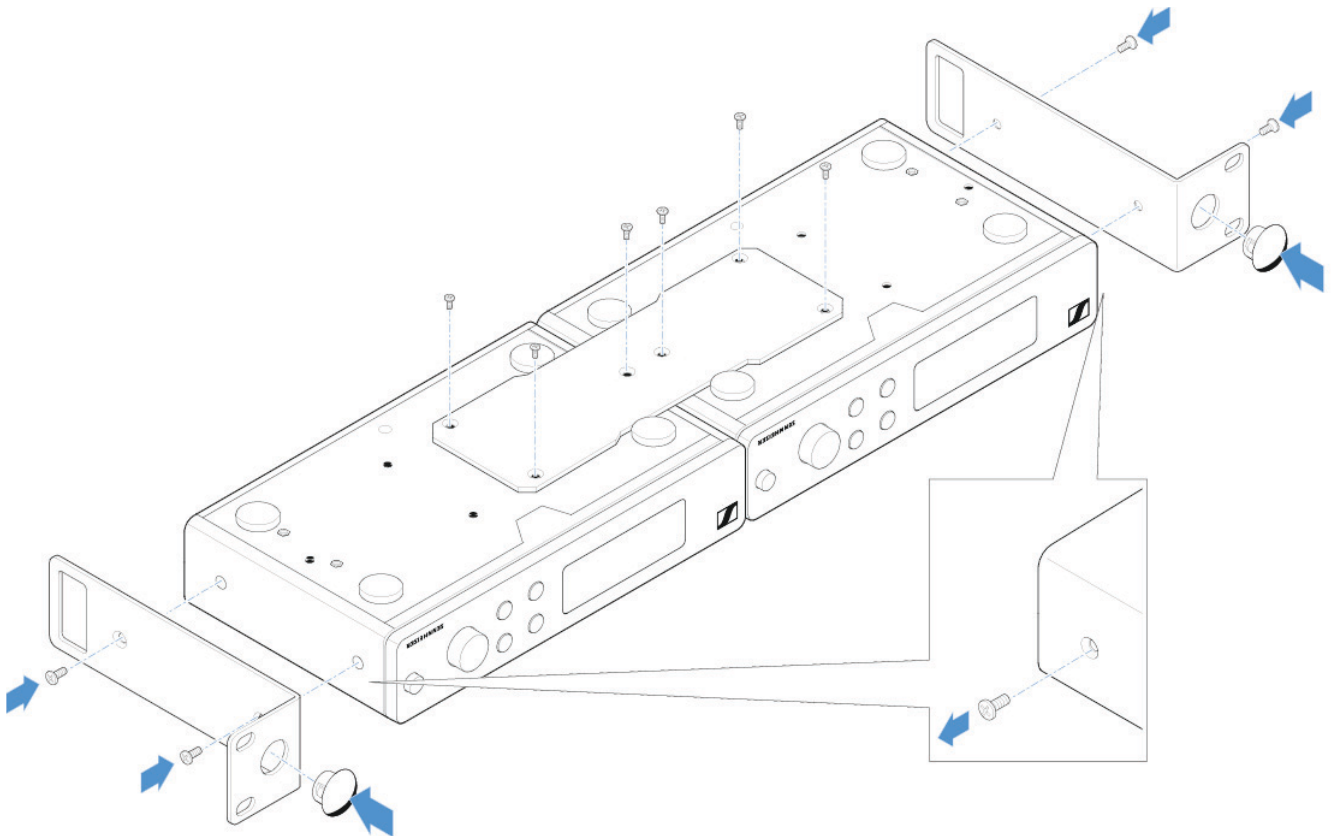



## Switching the receiver on and off

To switch the receiver **on**:

- ▷ Short-press the **ON/OFF** button.  
The receiver switches on.



To switch the receiver to **standby mode**:

- ▷ Hold down the **ON/OFF** button until the display switches off.

To **switch the receiver off completely**:

- ▷ Disconnect the receiver from the power supply system by unplugging the power supply unit from the wall socket.



## Information on the receiver's display

Status information such as frequency, reception quality, battery status and audio level is shown on the display.

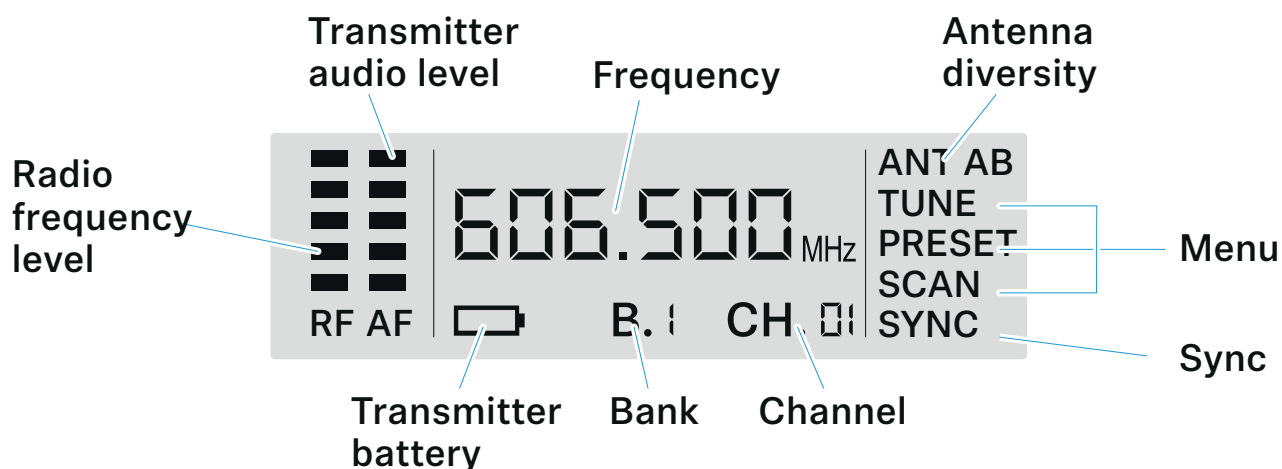

### Further information

Antenna diversity:

- Shows which of the two antennas is currently being used for the radio link (ANT A or ANT B)

Radio frequency level / Sync:

- „Establishing a radio link | Synchronizing the receiver and transmitter“

Frequency / Bank / Channel:

- „SCAN menu item“
- „PRESET menu item“
- „TUNE menu item“

Menu:

- „Setting options on the front of the device“



---

Transmitter battery:

- XSW-SKM -> „Inserting and removing the batteries“
  - XSW-SK -> „Inserting and removing the batteries“
- 

Transmitter audio level:

- XSW-SKM -> „Setting the input sensitivity“
  - XSW-SK -> „Setting the input sensitivity“
-





## Setting options on the front of the device

### Navigation buttons

Use the following buttons to navigate through the receiver's settings.

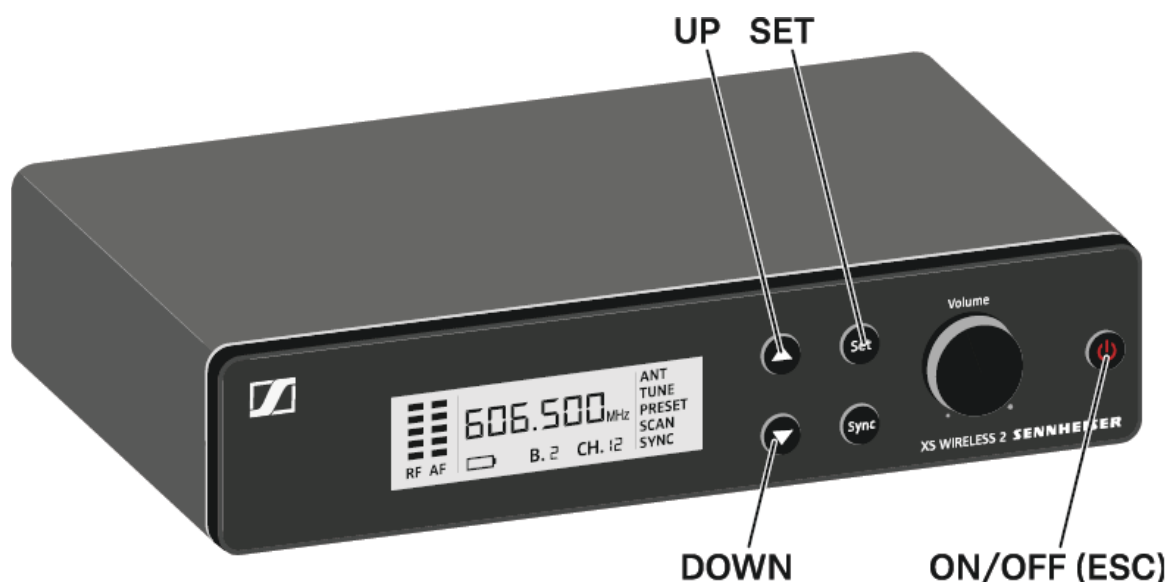

---

Press the **UP** or **DOWN** button

- Changes to the previous or next menu item
- Changes the setting of a menu item

---

Press the **SET** button

- Save settings in a menu item

---

Press the **ON/OFF (ESC)** button

- Cancel input
-



## SCAN menu item

Under the **SCAN** menu item, you can perform an automatic frequency scan of your area. This enables you to easily find and assign free radio frequencies.

Switch off all transmitters before you perform the scan. If transmitters are still switched on, they are detected as unavailable frequencies and the frequencies that are actually available cannot then be used.

- ▷ Press the **UP** or **DOWN** button until the **SCAN** menu item appears in the display.
- ▷ Press the **SET** button to open the menu item.



 SKM/SK off!



SCAN



Select bank



Start scan

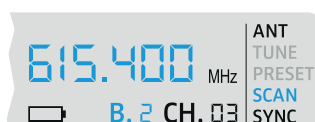

Select frequency



Save frequency



- ▷ Press the **UP** or **DOWN** button to select a frequency bank.
- ▷ Press the **SET** button to start the frequency scan in the selected bank.

The next free frequency is shown on the display.

- ▷ Press the **SET** button to accept the displayed frequency.  
or
- ▷ Press the **UP** or **DOWN** button to display the next free frequency.

or

- ▷ Press the **ON/OFF (ESC)** button to cancel the scan.  
The previous frequency remains unchanged.



If you have set a new frequency, you must still **synchronize** the **receiver** with the **transmitter** to establish the radio link (see „Establishing a radio link | Synchronizing the receiver and transmitter“).

## PRESET menu item

Under the **PRESET** menu item, you can set the radio frequency by selecting a preset channel.



If you are not sure whether the selected frequency is free, we recommend performing a scan to detect all free frequencies: „SCAN menu item“.

- ▷ Press the **UP** or **DOWN** button until the **PRESET** menu item appears in the display.
- ▷ Press the **SET** button to open the menu item.



PRESET



Select bank



Save bank



Select channel

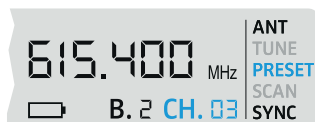

Save frequency

- ▷ Press the **UP** or **DOWN** button to select a frequency bank.
  - ▷ Press the **SET** button to save the selected frequency bank.
  - ▷ Press the **UP** or **DOWN** button to select a channel in the frequency bank.
  - ▷ Press the **SET** button to save the selected channel.
- or
- ▷ Press the **ON/OFF (ESC)** button to cancel the setting.
  - ▷ The previous frequency remains unchanged.



If you have set a new frequency, you must still **synchronize** the **receiver** with the **transmitter** to establish the radio link (see „Establishing a radio link | Synchronizing the receiver and transmitter“).



## TUNE menu item

Under the **TUNE** menu item, you can manually set the radio frequency independently of the preset channels.



If you are not sure whether the selected frequency is free, we recommend performing a scan to detect all free frequencies: „SCAN menu item“.

- ▷ Press the **UP** or **DOWN** button until the **TUNE** menu item appears in the display.
- ▷ Press the **SET** button to open the menu item.



TUNE

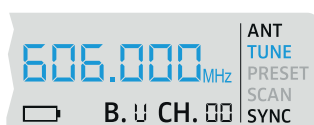

Set frequency



Save frequency

- ▷ Press the **UP** or **DOWN** button to set the frequency.
  - ▷ Press the **SET** button to accept the displayed frequency.
- or
- ▷ Press the **ON/OFF (ESC)** button to cancel the setting.
  - ▷ The previous frequency remains unchanged.



If you have set a new frequency, you must still **synchronize** the **receiver** with the **transmitter** to establish the radio link (see „Establishing a radio link | Synchronizing the receiver and transmitter“).



## Adjusting the volume of the audio outputs

Use the **VOLUME** control knob to set the level of the audio signal coming from the receiver's audio outputs (**Balanced/Unbalanced**). This audio signal can be output to a mixing console or an amplifier, for example.

- ▷ Turn the **VOLUME** control knob to adjust the volume.



- ▷ Make sure that the signal in the next device in the signal chain (e.g. mixing console, power amplifier, guitar amplifier, etc.) is not overdriven.



## Setting options on the rear of the device

### Selecting the signal type (Mic/Line)



- ▷ Set the **Line/Mic** switch to the desired position.
  - **Line:** when using instruments or other line sources with the SK-XSW bodypack transmitter
  - **Mic:** when using the SKM-XSW handheld transmitter or a microphone with the SK-XSW bodypack transmitter

### Setting the squelch

The squelch function can be used to suppress disturbing noise during transmission, such as hiss. If the signal level is below the squelch threshold, the signal is muted.

If the squelch threshold is set very high, this will shorten the radio range.



- ▷ Turn the control knob to the left or right to adjust the squelch.



## Configuring a multi-channel system

Please note when creating multi-channel systems:

Only the factory-preset transmission frequencies within one frequency bank are intermodulation-free.

- ▷ Set the same channel bank for all receivers.
- ▷ Assign one channel from this channel bank to each receiver.

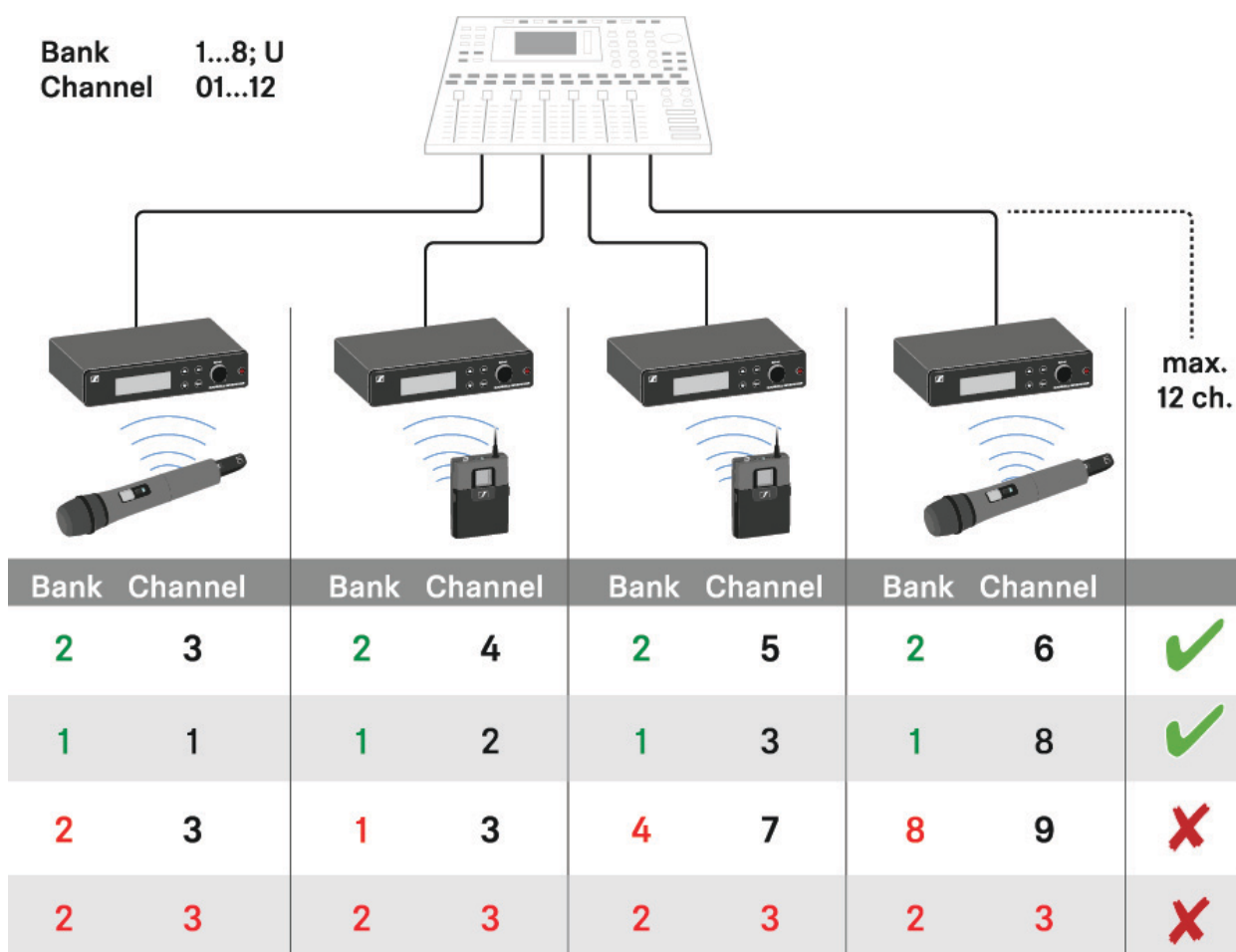

We recommend using the **SCAN** function, as this is the most reliable way to identify free frequencies (see „SCAN menu item“).

If you know free frequencies in your area, you can also set the frequency manually (see „PRESET menu item“ and „TUNE menu item“).





# Handheld transmitters SKM 825-XSW | SKM 835-XSW | SKM 865-XSW

## Product overview

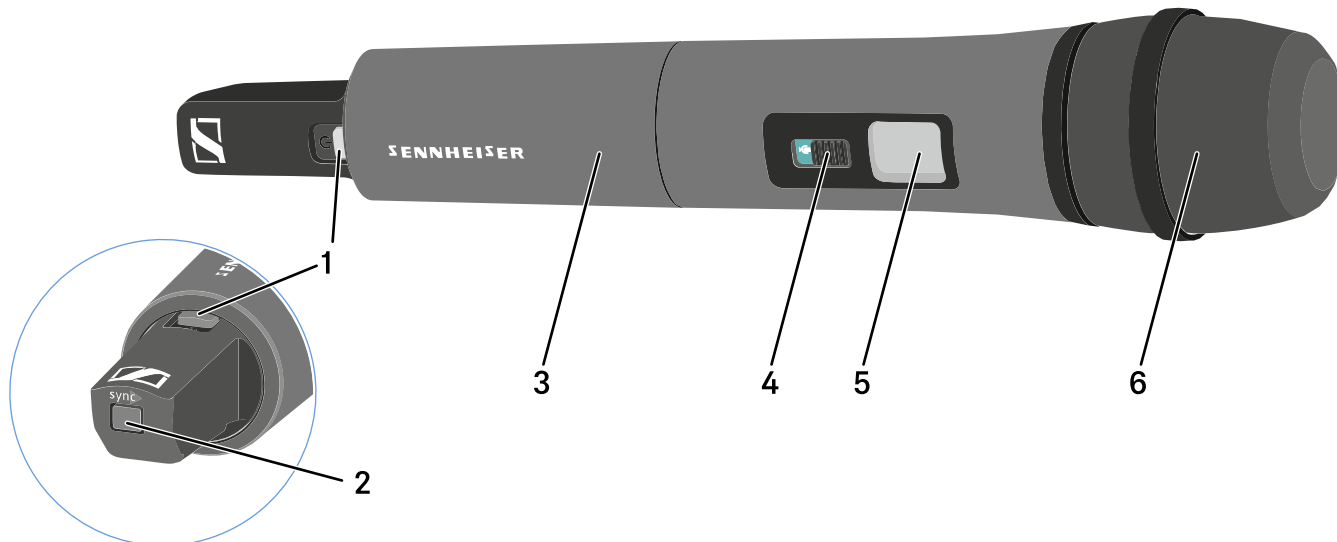

### 1 ON/OFF button with LED

- See „Switching the handheld transmitter on and off“
- Green: the radio link is established
- Flashing red/green: pairing active (see „Establishing a radio link | Synchronizing the receiver and transmitter“)
- Flashing red: low battery (see „Inserting and removing the batteries“)

### 2 SYNC button

- See „Establishing a radio link | Synchronizing the receiver and transmitter“

### 3 Unscrewable cover for accessing the battery compartment and **Sensitivity** switch

- See „Inserting and removing the batteries“
- See „Setting the input sensitivity“

### 4 Mute switch

- See „Muting the handheld transmitter“

### 5 Display panel

- See „Information on the handheld transmitter’s display“

### 6 Microphone module

- With capsule 825, 835 or 865



## Inserting and removing the batteries

You need two AA 1.5 V batteries to operate the handheld transmitter.

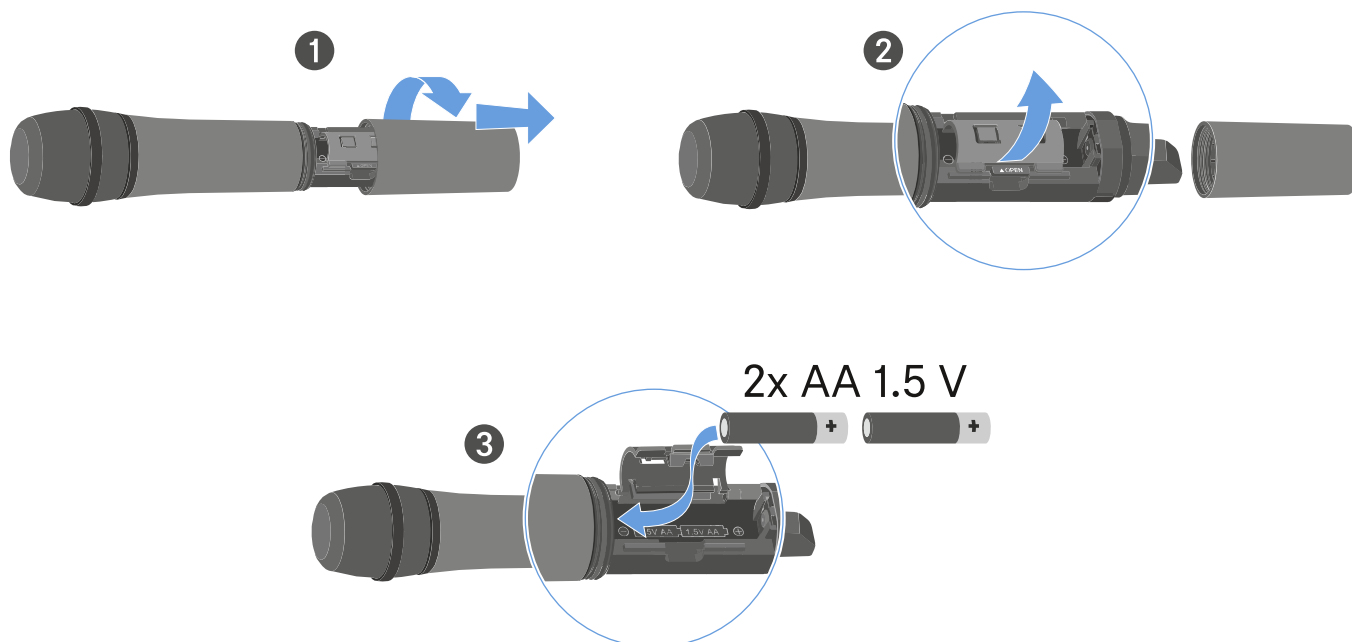

- ▷ Unscrew the microphone housing as shown in the figure and pull it downward.
- ▷ Insert the batteries as indicated in the battery compartment. Observe correct polarity.
- ▷ Screw the microphone housing back on.



## Battery status

Battery charge status in the display:

| Bank | Ch. | Charge Status        | Approx. Runtime |
|------|-----|----------------------|-----------------|
| 1    | 1   | [Full battery icon]  | ~ 10 h          |
|      |     | [3/4 battery icon]   | ~ 7 h           |
|      |     | [1/4 battery icon]   | ~ 3 h           |
|      |     | [Empty battery icon] | Low Batt        |

Charge status is critical (LOW BATT):

SK-XSW



SKM-XSW

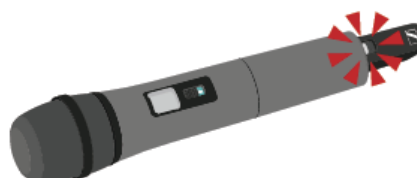

EM-XSW 1 /EM-XSW 1 DUAL



EM-XSW 2





## Switching the handheld transmitter on and off

To switch the handheld transmitter on:

- ▷ Short-press the **ON/OFF** button.  
The transmitter switches on. The **ON/OFF** button lights up.

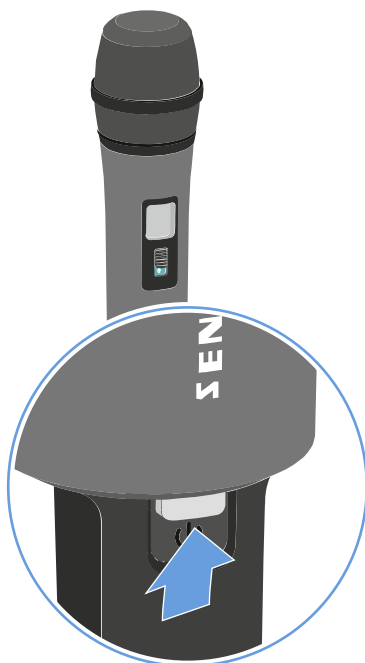

To switch the handheld transmitter off:

- ▷ Hold down the **ON/OFF** button until the light in the **ON/OFF** button disappears.

## Establishing a connection to the receiver

To establish a radio link between the transmitter and the receiver, the devices must be synchronized.

See „Establishing a radio link | Synchronizing the receiver and transmitter“.



### Conditions and restrictions for using frequencies

There may be special conditions and restrictions for using frequencies in your country.

Before putting the product into operation, find the information for your country at the following address:

[www.sennheiser.com/sifa](http://www.sennheiser.com/sifa)



## Information on the handheld transmitter's display

You can view the following information on the transmitter display.

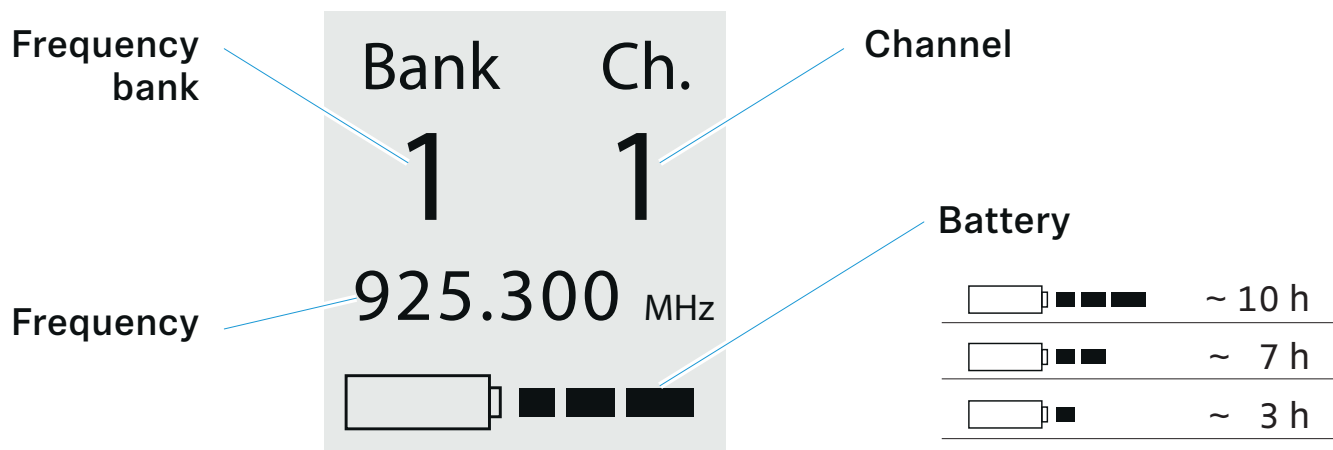

### Further information

Frequency bank / Channel / Frequency:

- EM-XSW 1: „Setting the frequency automatically (AUTO SCAN)“ | „Setting the frequency manually“
- EM-XSW 1 DUAL: „Setting the frequency automatically (AUTO SCAN)“ | „Setting the frequency manually“
- EM-XSW 2: „SCAN menu item“ | „PRESET menu item“ | „TUNE menu item“

Battery:

- „Inserting and removing the batteries“



## Setting the input sensitivity

Use the **Sensitivity** switch to adjust the level of the audio signal sent to the receiver.

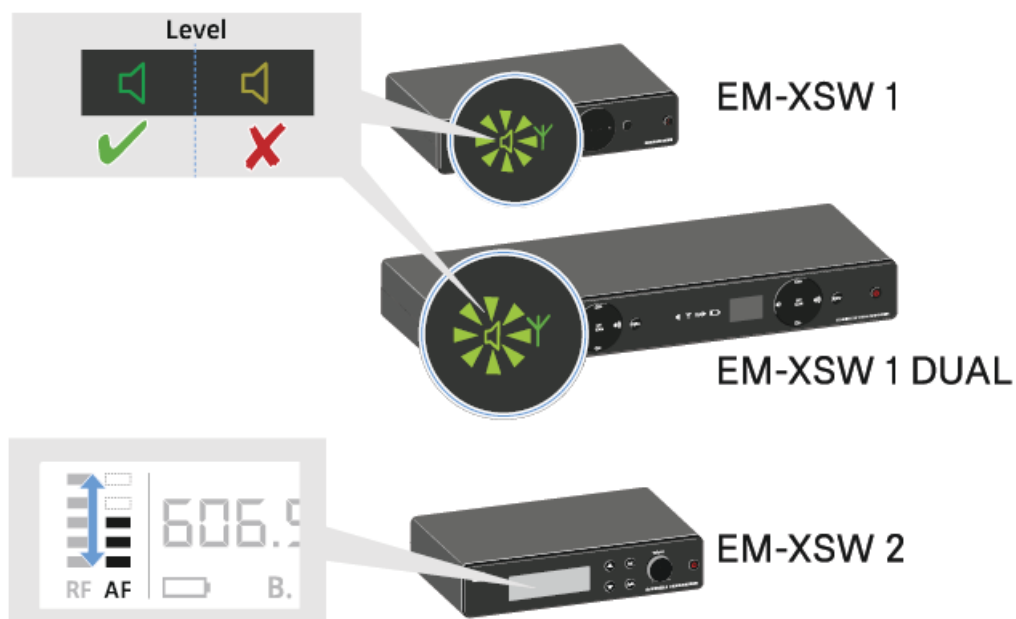

- ▷ Unscrew the microphone housing and pull it downward.
- ▷ Adjust the input sensitivity using the **Sensitivity** switch.
- ▷ Pay attention to the level indicator on the receiver display.



## Muting the handheld transmitter

You can mute the audio signal using the mute switch.

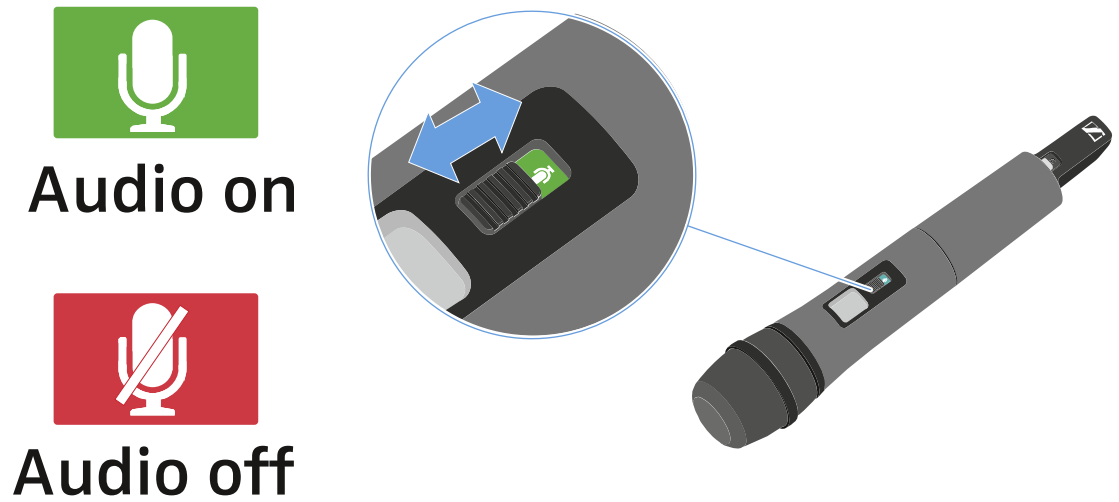

- ▷ Slide the mute switch to the desired position to mute or activate the audio signal.



# SK-XSW bodypack transmitter

## Product overview

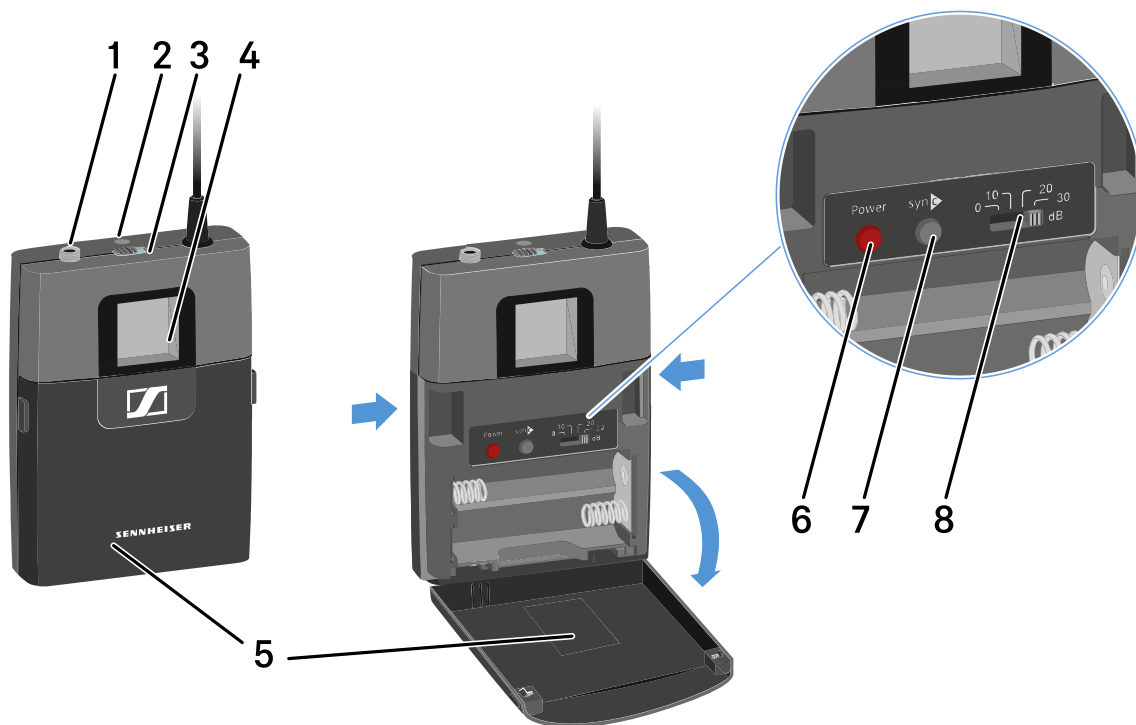

- 1** 3.5 mm input jack socket
  - See „Connecting a microphone to the bodypack transmitter“
  - See „Connecting an instrument or line source to the bodypack transmitter“
- 2** LED
  - Green: the radio link is established
  - Flashing red/green: pairing active (see „Establishing a radio link | Synchronizing the receiver and transmitter“)
  - Flashing red: low battery (see „Inserting and removing the batteries“)
- 3** Mute switch
  - See „Muting the bodypack transmitter“
- 4** Display panel
  - See „Information on the bodypack transmitter’s display“
- 5** Battery compartment cover
  - See „Inserting and removing the batteries“
- 6** ON/OFF (Power) button
  - See „Switching the bodypack transmitter on and off“





## 7 SYNC button

- See „Establishing a radio link | Synchronizing the receiver and transmitter“

## 8 Sensitivity switch

- See „Setting the input sensitivity“

## Inserting and removing the batteries

You need two AA 1.5 V batteries to operate the handheld transmitter.

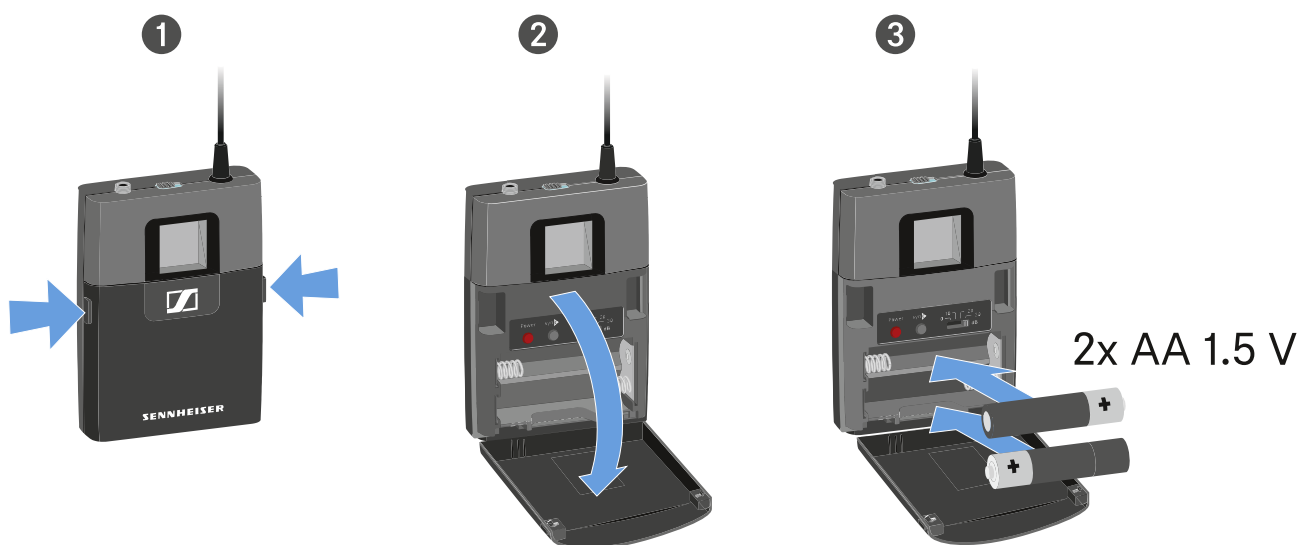

- ▷ Press the two catches and open the battery compartment cover.
- ▷ Insert the batteries as shown in the figure. Observe correct polarity.
- ▷ Close the battery compartment.  
The cover locks into place with an audible click.



## Battery status

Battery charge status in the display:

| Bank | Ch. | Charge Status       | Approx. Runtime |
|------|-----|---------------------|-----------------|
| 1    | 1   | [Full battery icon] | ~ 10 h          |
|      |     | [3/4 battery icon]  | ~ 7 h           |
|      |     | [1/2 battery icon]  | ~ 3 h           |
|      |     | [Low battery icon]  | Low Batt        |

925.300 MHz

Charge status is critical (LOW BATT):

SK-XSW



SKM-XSW

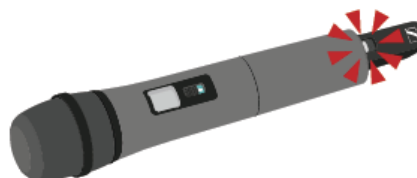

EM-XSW 1 /EM-XSW 1 DUAL



EM-XSW 2





## Connecting a microphone to the bodypack transmitter

To connect a microphone to the bodypack transmitter:

- ▷ Insert the cable's 3.5 mm jack plug into the socket on the bodypack transmitter as shown in the diagram.
- ▷ Screw the plug's coupling ring onto the audio socket thread of the bodypack transmitter.

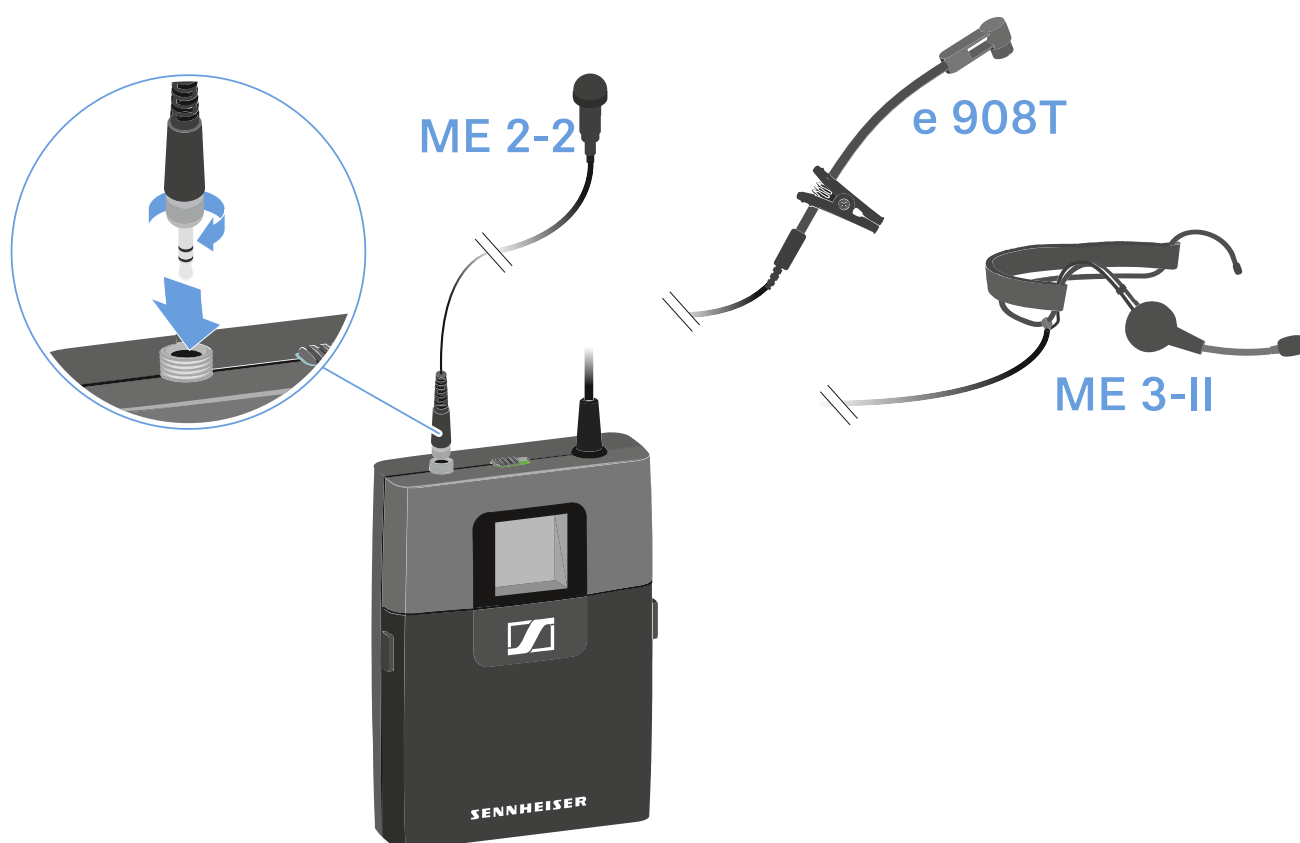

## Connecting an instrument or line source to the bodypack transmitter

You can connect instruments or audio sources with a line level to the bodypack transmitter.

To do so, you require the Sennheiser **CI 1-N** cable (6.3 mm jack plug to lockable 3.5 mm jack plug).

To connect an instrument or line source to bodypack transmitter:



- ▷ Insert the cable's 3.5 mm jack plug into the socket on the bodypack transmitter as shown in the diagram.
- ▷ Screw the plug's coupling ring onto the audio socket thread of the bodypack transmitter.

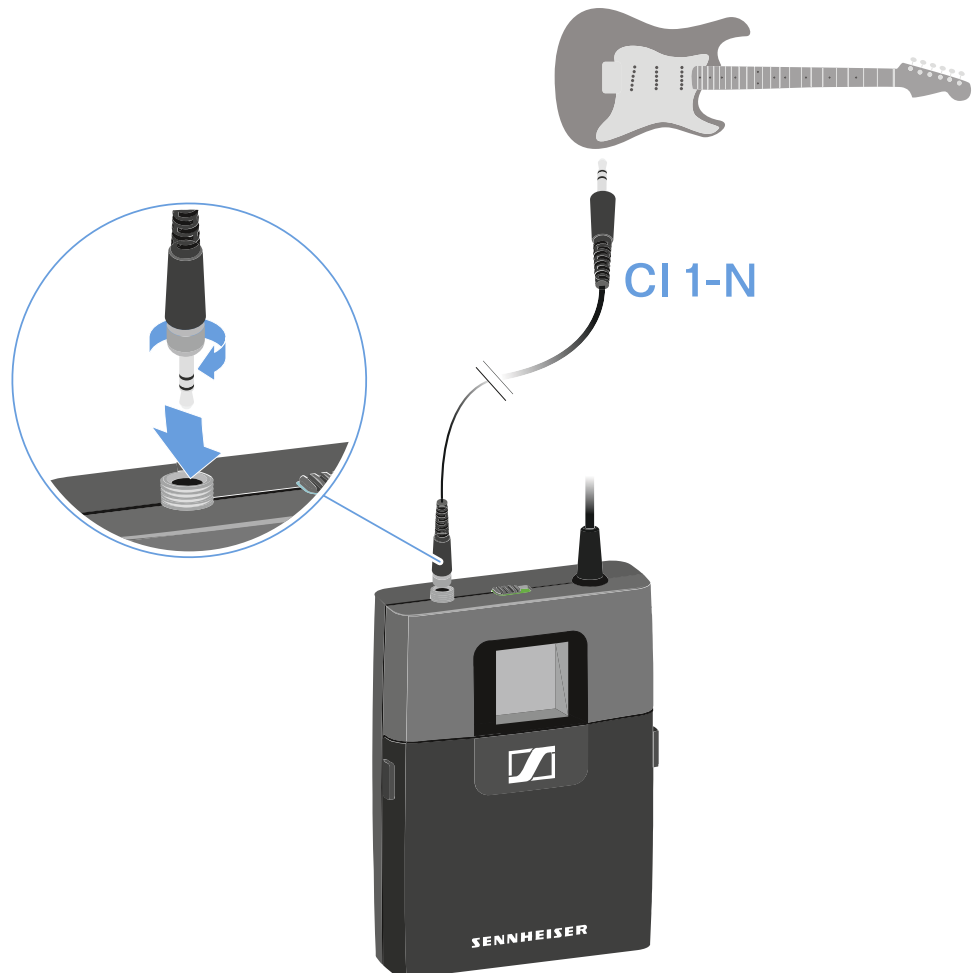



## Switching the bodypack transmitter on and off

To switch the bodypack transmitter on:

- ▷ Short-press the **ON/OFF** button.  
The transmitter switches on. The LED lights up.

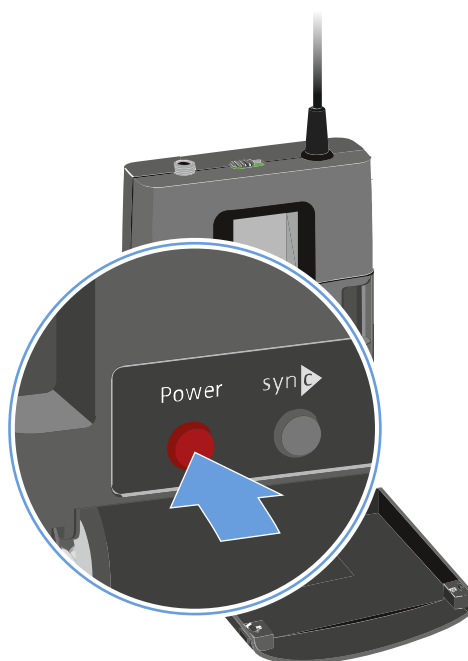

To switch the bodypack transmitter off:

- ▷ Hold down the **ON/OFF** button until the LED switches off.

## Establishing a connection to the receiver

To establish a radio link between the transmitter and the receiver, the devices must be synchronized.

See „Establishing a radio link | Synchronizing the receiver and transmitter“.



### Conditions and restrictions for using frequencies

There may be special conditions and restrictions for using frequencies in your country.

Before putting the product into operation, find the information for your country at the following address:

[www.sennheiser.com/sifa](http://www.sennheiser.com/sifa)



## Information on the bodypack transmitter's display

You can view the following information on the transmitter display.

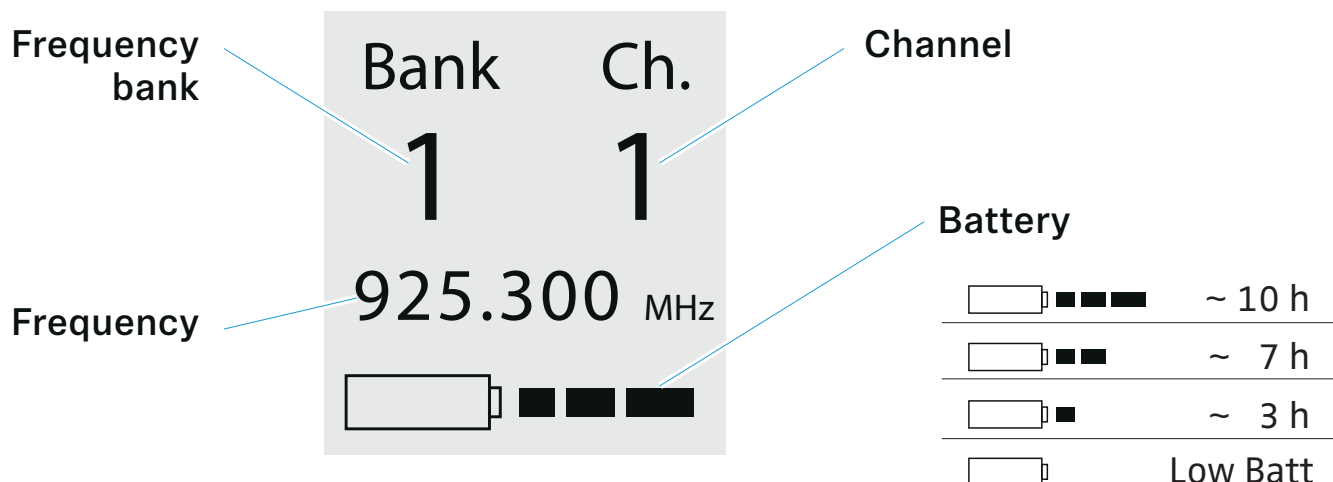

### Further information

---

Frequency bank / Channel / Frequency:

- EM-XSW 1: „Setting the frequency automatically (AUTO SCAN)“ | „Setting the frequency manually“
- EM-XSW 1 DUAL: „Setting the frequency automatically (AUTO SCAN)“ | „Setting the frequency manually“
- EM-XSW 2: „SCAN menu item“ | „PRESET menu item“ | „TUNE menu item“

---

Battery:

- „Inserting and removing the batteries“
-



## Setting the input sensitivity

Use the **Sensitivity** switch to adjust the level of the audio signal sent to the receiver.

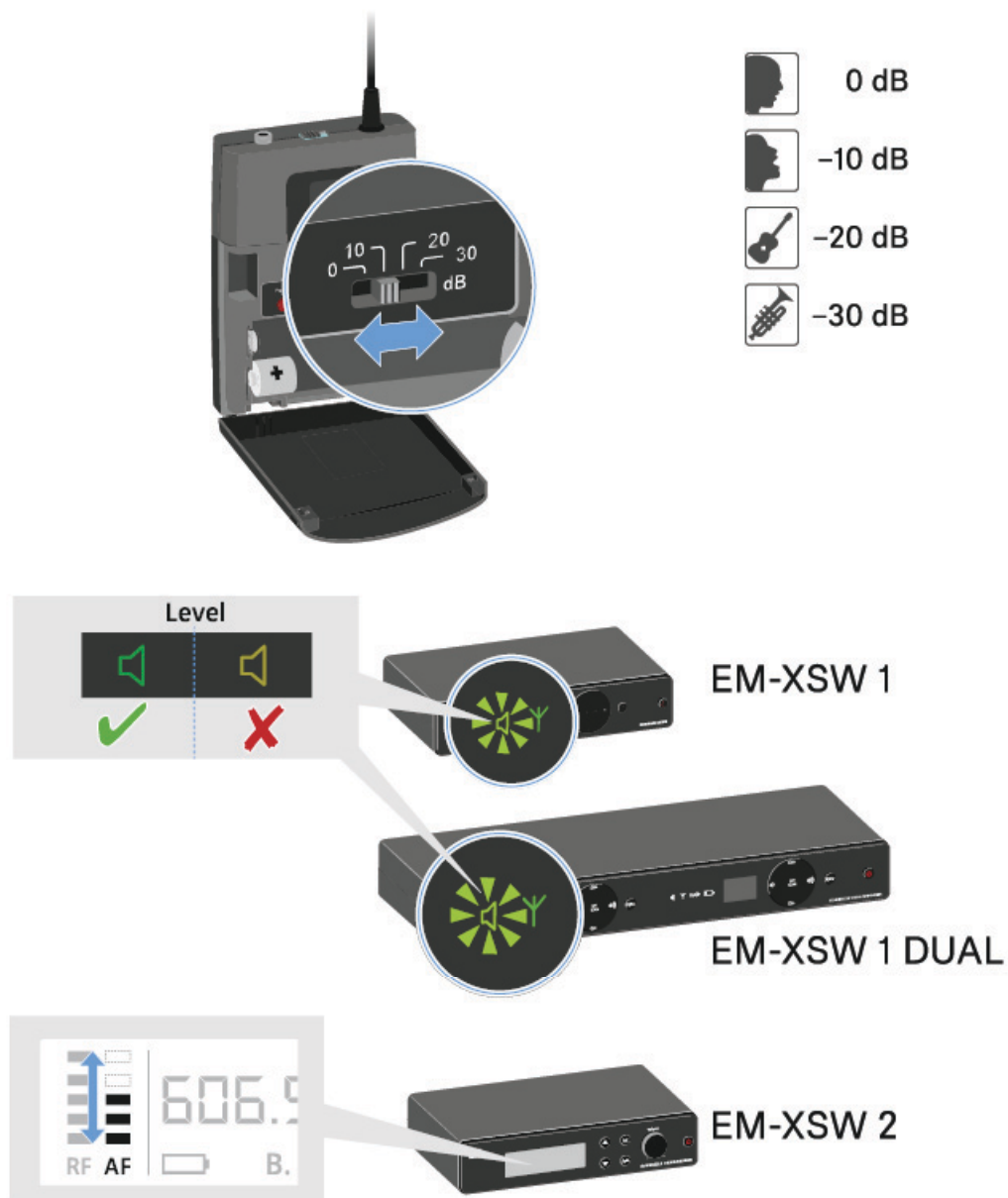

- ▷ Press the two catches and open the battery compartment cover.
- ▷ Adjust the input sensitivity using the **Sensitivity** switch.
- ▷ Pay attention to the level indicator on the receiver display.



## Muting the bodypack transmitter

You can mute the audio signal using the mute switch.

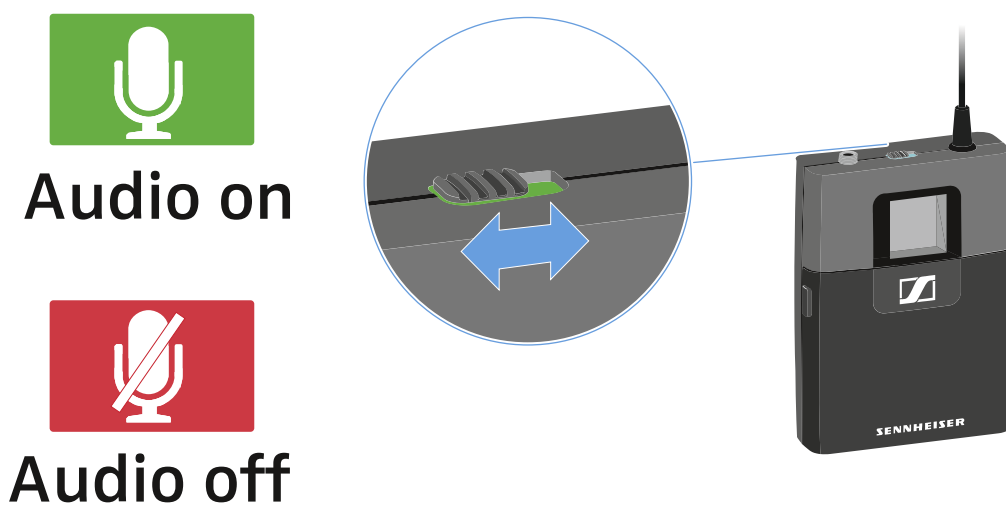

- Slide the mute switch to the desired position to mute or activate the audio signal.





## Establishing a radio link | Synchronizing the receiver and transmitter

---



### Conditions and restrictions for using frequencies

There may be special conditions and restrictions for using frequencies in your country.

Before putting the product into operation, find the information for your country at the following address:

[www.sennheiser.com/sifa](http://www.sennheiser.com/sifa)

---

To establish a radio link between the transmitter and receiver, we recommend the following procedure.



To successfully pair a receiver and a transmitter, both devices must have the same frequency range.

### Step 1: Set a free frequency on the receiver

We recommend using the **AUTO SCAN** function, as this is the most reliable way to identify free frequencies (EM-XSW 1: „Setting the frequency automatically (AUTO SCAN)“ | EM-XSW 1 DUAL: „Setting the frequency automatically (AUTO SCAN)“ | EM-XSW 2: „SCAN menu item“).

If you know free frequencies in your area, you can also set the frequency manually (EM-XSW 1: „Setting the frequency manually“ | EM-XSW 1 DUAL: „Setting the frequency manually“ | EM-XSW 2: „PRESET menu item“ or „TUNE menu item“).

### Step 2: Synchronize the receiver and transmitter

- ▷ Press and hold the **SYNC** button on the transmitter. The LED flashes alternately red and green.
- ▷ While the LED is flashing, short-press the **SYNC** button on the receiver. The transmitter and receiver are synchronized and the connection is established.

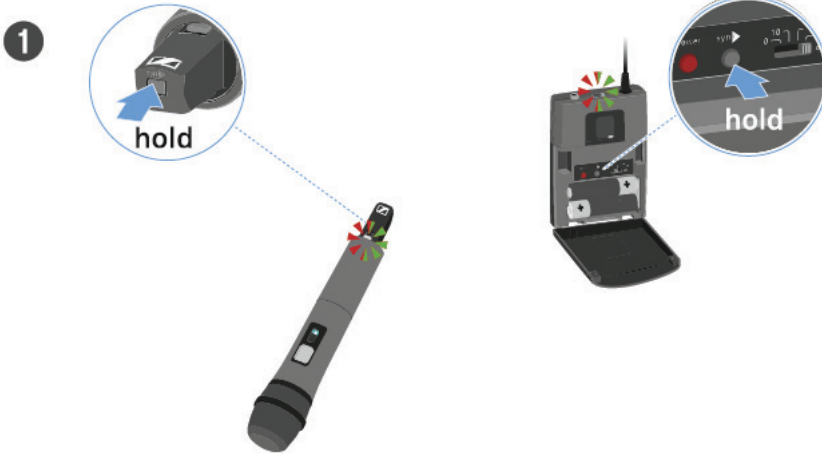

2 EM-XSW 1 / EM-XSW 1 DUAL

EM-XSW 2



3 EM-XSW 1 / EM-XSW 1 DUAL



EM-XSW 2





## Cleaning and maintenance

Note the following information when cleaning and maintaining products of the Evolution Wireless Digital series.

---

### CAUTION

#### **Liquids can damage the products' electronics.**

Liquids entering the product housing can cause a short-circuit and damage the electronics.

- ▷ Keep all liquids away from the products.
- ▷ Do not use any solvents or cleansing agents.

- 
- ▷ Disconnect the products from the power supply system and remove rechargeable batteries and batteries before you begin cleaning.
  - ▷ Clean all products only with a soft, dry cloth.
  - ▷ Note the special cleaning instructions below for the following products.

#### **Cleaning the sound inlet basket of the microphone module**

- ▷ Unscrew the top sound inlet basket from the microphone module by turning it counterclockwise.
- ▷ Remove the foam insert.

You can clean the sound inlet basket in two ways:

- Use a slightly damp cloth to clean the top sound inlet basket from the inside and outside.
- Use a brush and rinse with clean water.
- ▷ If necessary, clean the foam insert with a mild detergent or replace the foam insert.
- ▷ Dry the top sound inlet basket and foam insert.
- ▷ Reinsert the foam insert.
- ▷ Screw the sound inlet basket back onto the microphone module.



From time to time, you should also clean the microphone module contacts:

- ▷ Wipe the contacts of the microphone module with a soft, dry cloth.

### **Cleaning the bodypack transmitter contacts**

Wipe the contacts with a dry cloth.



# SPECIFICATIONS

## System

### Modulation

Wideband FM

### Frequency ranges

- **A:** 548 – 572 MHz
- **GB:** 606 – 630 MHz
- **B:** 614 – 638 MHz
- **BC:** 670 – 694 MHz
- **C:** 630 – 662 MHz
- **D:** 766 – 790 MHz
- **JB:** 806.125 – 809.750 MHz
- **E:** 821 – 832 MHz & 863 – 865 MHz
- **K:** 925 – 937.5 MHz

Further details: „Frequency ranges“

### Switching bandwidth

up to 24 MHz

### Frequencies

- XSW 1:
  - 8 frequency banks, each with up to 10 factory-preset channels
- XSW 2:
  - adjustable in 25 kHz steps
  - 8 frequency banks, each with up to 12 factory-preset channels

### Transmitter synchronization

- XSW 1:
  - 2.4 GHz, RF power < 3 mW, MSK (only active during synchronization)
- XSW 2:
  - 2.4 GHz, RF power < 3 mW, Low Power OQPSK (only active during synchronization)

**Signal-to-noise ratio**

≥ 103 dBA

**Audio THD**

≤ 0.9 %

**Operating temperature range**

0 °C – +40 °C (14 °F – 131 °F)

**Storage temperature range**

-20 °C – +70 °C (14 °F – 131 °F)

**Relative humidity**

max. 95 % (non-condensing)



# EM-XSW 1 stationary receiver

## Receiver principle

double superheterodyne

## Diversity principle

Antenna switching diversity via internal antennas

## Sensitivity (at peak deviation)

< 3  $\mu$ V at 52 dB(A)eff S/N

## AF frequency response

50 – 16,000 Hz (-3 dB)

## Max. AF output voltage (at peak deviation, 1 kHz AF)

- 6.3 mm jack socket (unbalanced): +6 dBu
- XLR socket (balanced): +12 dBu

## Audio adjustment range

45 dB, adjustable in 5 dB steps

## Power supply

DC 12 V nom. / 300 mA

## Squelch

Adjustable from 3 dB $\mu$ V up to 28 dB $\mu$ V (combined with pilot tone)

## Line/Mic level

20 dB, switchable

## Housing material

rugged ABS housing



**Dimensions**

Approx. 200 x 42 x 127 mm

**Weight**

Approx. 340 g





# EM-XSW 1 DUAL rack receiver

## **Receiver principle**

double superheterodyne

## **Diversity principle**

Antenna switching diversity via internal antennas

## **Sensitivity (at peak deviation)**

< 3  $\mu$ V at 52 dB(A)eff S/N

## **AF frequency response**

50 – 16,000 Hz (-3 dB)

## **Max. AF output voltage (at peak deviation, 1kHz AF)**

- 6.3 mm jack socket (unbalanced): +6 dBu
- XLR socket (balanced): +12 dBu

## **Audio adjustment range**

45 dB, adjustable in 5 dB steps

## **Power supply**

DC 12 V nom. / 500 mA

## **Squelch**

Adjustable from 3 dB $\mu$ V up to 28 dB $\mu$ V (combined with pilot tone)

## **Line/Mic level**

20 dB, switchable

## **Housing material**

rugged ABS housing



**Dimensions**

Approx. 320 x 42 x 127 mm

**Weight**

Approx. 610 g



## EM-XSW 2 stationary receiver

### Receiver principle

double superheterodyne

### Diversity principle

True diversity

### Sensitivity (at peak deviation)

< 3  $\mu$ V at 52 dB(A)eff S/N

### AF frequency response

50 – 16,000 Hz (-3 dB)

### Max. AF output voltage (at peak deviation, 1kHz AF)

- 6.3 mm jack socket (unbalanced): +6 dBu
- XLR socket (balanced): +12 dBu

### Audio adjustment range

40 dB, continuously adjustable with control knob

### Power supply

DC 12 V nom. / 300 mA

### Squelch

Adjustable from 3 dB $\mu$ V up to 28 dB $\mu$ V (combined with pilot tone)

### Line/Mic level

20 dB, switchable

### Housing material

Rugged metal housing



**Dimensions**

Approx. 200 x 42 x 127 mm

**Weight**

Approx. 680 g



## SKM-XSW handheld transmitter

### Transmission power

10 mW

### AF frequency response

- SKM 825-XSW
  - 80 – 14,000 Hz
- SKM 835-XSW
  - 80 – 16,000 Hz
- SKM 865-XSW
  - 80 – 16,000 Hz

### Power supply

2 AA batteries, 1.5 V

### Operating time

approx. 10 hours

### Microphone type

- SKM 825-XSW
  - Dynamic
- SKM 835-XSW
  - Dynamic
- SKM 865-XSW
  - Capacitor, pre-polarized

### Input sensitivity (capsule)

- SKM 825-XSW
  - 1.5 mV/Pa
- SKM 835-XSW
  - 1.5 mV/Pa
- SKM 865-XSW
  - 1.8 mV/Pa

**Pick-up pattern**

- SKM 825-XSW
  - Cardioid
- SKM 835-XSW
  - Cardioid
- SKM 865-XSW
  - Super-cardioid

**Adjustment range of transmitter sensitivity**

0 to -30 dB, adjustable in 10 dB steps

**Housing material**

rugged ABS housing

**Dimensions**

Approx. 260 x 50 mm

**Weight**

Approx. 245 g



## SK-XSW bodypack transmitter

### Transmission power

10 mW

### AF frequency response

- 50 – 16,000 Hz (Line)
- 80 – 16,000 Hz (Mic)

### Audio input

3.5 mm jack socket

### Max. input voltage (Mic/Line) at 3% THD

- Typically 1.5 V rms Mic @ -30 dB gain
- Typically 2.6 V rms Line @ -30 dB gain

### Power supply

2 AA batteries, 1.5 V

### Operating time

approx. 10 hours

### Adjustment range of transmitter sensitivity

0 to -30 dB, adjustable in 10 dB steps

### Housing material

rugged ABS housing

### Dimensions

Approx. 71 x 96 x 28 mm

### Weight

Approx. 95 g



## Microphones

### ME 2-2

#### **Transducer principle**

Capacitor, pre-polarized

#### **Sensitivity**

20 mV/Pa

#### **Pick-up pattern**

Omni-directional

#### **Max. sound pressure level (SPL)**

130 dB

### ME 3-II

#### **Transducer principle**

Capacitor, pre-polarized

#### **Sensitivity**

1.6 mV/Pa

#### **Pick-up pattern**

Cardioid

#### **Max. sound pressure level (SPL)**

150 dB





## e 908T

### **Transducer principle**

Capacitor, pre-polarized

### **Sensitivity**

0.6 mV/Pa

### **Pick-up pattern**

Cardioid

### **Max. sound pressure level (SPL)**

147 dB



## NT 12-5 CW power supply unit

**Nominal input voltage**

AC 100 – 240 V

**Power frequency**

50 or 60 Hz

**Input current**

≤ 200 mA

**Nominal output voltage**

DC 12 V

**Output current**

≤ 500 mA

**Standby power consumption**

≤ 0.075 W @ AC 230 V

≤ 0.1 W @ AC 115 V

**Energy efficiency level**

DOE Level VI

**Weight (without adapter)**

Approx. 65 g

**Cable length**

approx. 1.83 m

**Operating temperature range**

0 °C – +40 °C (14 °F – 131 °F)



**Storage temperature range**

-20 °C – +60 °C (14 °F – 131 °F)

**Relative humidity**

max. 95 % (non-condensing)



## CONTACT



**Sennheiser electronic GmbH & Co. KG**

Am Labor 1, 30900 Wedemark, Germany  
[www.sennheiser.com](http://www.sennheiser.com)

### Questions about the product / Help with technical issues

If you have any technical questions or problems with the product, please contact Sennheiser customer service.

[www.sennheiser.com/service-support](http://www.sennheiser.com/service-support)

### Feedback on the instruction manual

Do you have any questions or suggestions about this instruction manual? Write to us at:

**[techcomm@sennheiser.com](mailto:techcomm@sennheiser.com)**